



REEFSCAPE

PRESENTED BY **HAS**
Gene Haas Foundation

FIRST® DIVESM
presented by Qualcomm

firstinspires.org/robotics/frc

2025 **FIRST**® Robotics Competition

Game Manual

With inspiration from
Operation Outpost by Team 1318, Issaquah Robotics Society.

Contents

1	Introduction.....	5
1.1	About <i>FIRST</i> ®.....	5
1.2	In Memoriam.....	5
1.3	<i>FIRST</i> ® Robotics Competition.....	5
1.4	<i>Gracious Professionalism</i> ®, a <i>FIRST</i> Credo.....	6
1.5	<i>Coopertition</i> ®.....	7
1.6	Spirit of Volunteering.....	8
1.7	This Document & Its Conventions.....	9
1.8	Translations & Other Versions.....	11
1.9	Team Updates.....	11
1.10	Question and Answer System.....	12
2	<i>FIRST</i> Season Overview.....	13
3	Game Sponsor Recognition.....	15
4	Game Overview.....	17
5	ARENA.....	19
5.1	FIELD.....	19
5.2	Areas, Zones, & Markings.....	21
5.3	REEF.....	23
5.4	BARGE.....	25
5.4.1	CAGE.....	26
5.4.2	NET.....	27
5.5	PROCESSOR.....	28
5.6	ALLIANCE WALL.....	29
5.6.1	DRIVER STATIONS.....	29
5.6.2	CORAL STATION.....	32
5.7	SCORING ELEMENTS.....	32
5.7.1	CORAL.....	33
5.7.2	ALGAE.....	34
5.8	AprilTags.....	34
5.9	The FIELD Management System.....	38
5.10	FIELD STAFF.....	39
6	Game Details.....	41
6.1	MATCH Overview.....	41
6.2	DRIVE TEAM.....	41
6.3	Setup.....	43
6.3.1	DRIVE TEAMS.....	43
6.3.2	OPERATOR CONSOLES.....	43
6.3.3	ROBOTS.....	43
6.3.4	SCORING ELEMENTS.....	44
6.3.5	CAGES.....	45
6.4	MATCH Phases.....	46
6.5	Scoring.....	46
6.5.1	SCORING ELEMENT Scoring Criteria.....	46
6.5.2	ROBOT Scoring Criteria.....	47

6.5.3	Coopertition Bonus.....	48
6.5.4	Point Values	48
6.6	Violations	48
6.6.1	YELLOW and RED CARDS.....	49
6.6.2	YELLOW and RED CARD application.....	50
6.6.3	YELLOW and RED CARDS during Playoff MATCHES.....	50
6.6.4	Violation Details	50
6.7	Head REFEREE and FTA Interaction.....	51
6.7.1	Question Box (Q).....	52
6.8	Other Logistics.....	52
7	Game Rules (G).....	55
7.1	Personal Safety.....	55
7.2	Conduct	56
7.3	Pre-MATCH	60
7.4	In-MATCH.....	63
7.4.1	AUTO.....	63
7.4.2	SCORING ELEMENTS.....	63
7.4.3	ROBOT.....	65
7.4.4	Opponent Interaction	67
7.4.5	Human	70
7.5	Post-MATCH	71
8	ROBOT Construction Rules (R)	73
8.1	General ROBOT Design.....	75
8.2	ROBOT Safety & Damage Prevention.....	77
8.3	Budget Constraints & Fabrication Schedule	78
8.4	BUMPER Rules	82
8.5	Motors & Actuators	87
8.6	Power Distribution	92
8.7	Control, Command & Signals System	101
8.8	Pneumatic System.....	105
8.9	OPERATOR CONSOLE	109
9	Inspection & Eligibility (I).....	111
9.1	Rules.....	111
10	Tournaments (T).....	115
10.1	MATCH Schedules.....	115
10.2	MATCH Replays.....	115
10.3	Measurement.....	116
10.4	Practice MATCHES.....	117
10.4.1	Filler Line.....	117
10.5	Qualification MATCHES	117
10.5.1	Schedule	117
10.5.2	MATCH Assignment	117
10.5.3	Qualification Ranking.....	118
10.6	Playoff MATCHES.....	119
10.6.1	ALLIANCE Selection Process.....	119
10.6.2	Playoff MATCH Bracket.....	121

10.6.3	BACKUP TEAMS.....	124
10.6.4	LINEUPS.....	126
10.6.5	Pit Crews.....	127
10.6.6	Small Event Exceptions	127
11	District Tournaments	129
11.1	District Events	129
11.1.1	Qualification Round Performance	130
11.1.2	ALLIANCE Selection Results	131
11.1.3	Playoff Performance.....	131
11.1.4	Awards.....	132
11.1.5	Team Age.....	132
11.1.6	Regional Participation.....	132
11.2	District Championship Eligibility	132
11.3	District Championships with Multiple Divisions.....	133
11.4	District Championship Playoffs.....	134
11.5	FIRST Championship Eligibility	136
12	Regional Tournaments.....	139
12.1	Regional Events	139
12.1.1	Awards.....	140
12.1.2	Team Age.....	140
12.2	FIRST Championship Eligibility	140
12.3	Regional Pool.....	141
12.3.1	Single-event team points calculation	141
13	FIRST Championship Tournament (C).....	143
13.1	Advancement to the FIRST Championship	143
13.2	4-ROBOT ALLIANCES	143
13.3	FIRST Championship Pit Crews	143
13.4	FIRST Championship Playoffs	144
14	Event Rules (E).....	145
14.1	General Rules	145
14.2	Machine Shops	148
14.3	Wireless Rules.....	149
14.4	Load-In.....	149
14.5	Pits.....	150
14.6	Practice Areas.....	151
14.7	ROBOT Carts	152
14.8	Ceremonies	152
14.9	In the Stands	153
15	Glossary	155

1 Introduction

1.1 About FIRST®

FIRST® (For Inspiration and Recognition of Science and Technology) was founded by inventor Dean Kamen to inspire young people's interest in science and technology. As a robotics community that prepares young people for the future, FIRST is the world's leading youth-serving nonprofit advancing STEM education. For 30 years, FIRST has combined the rigor of STEM learning with the fun and excitement of traditional sports and the inspiration that comes from community through programs that have a proven impact on learning, interest, and skill-building inside and outside of the classroom. FIRST provides programs that span a variety of age groups:

- FIRST® Robotics Competition for grades 9-12, ages 14-18
- FIRST® Tech Challenge for grades 7-12, ages 12-18
- FIRST® LEGO® League for grades Pre-K-8, ages 4-16
 - FIRST® LEGO® League Challenge for grades 4-8 (ages 9-16, ages vary by country)
 - FIRST® LEGO® League Explore for grades 2-4 (ages 6-10)
 - FIRST® LEGO® League Discover for grades Pre-K-1 (ages 4-6)

Please visit [the FIRST website](https://www.firstinspires.org) for more information about FIRST and its programs.

1.2 In Memoriam

In October 2019, Dr. Woodie Flowers, an innovator in design and engineering education and a Distinguished Advisor to FIRST and supporter of our mission, passed away. As thousands of heartfelt tributes to Woodie have poured in from around the world, it is clear his legacy will live on indefinitely through the gracious nature of our community and our ongoing commitment to empowering educators and building global citizens.

Figure 1-1 Dr. Woodie Flowers, 1943-2019



1.3 FIRST® Robotics Competition

FIRST® Robotics Competition combines the excitement of sport with the rigors of science and technology. Teams of students are challenged to design, build, and program industrial-size robots and compete for awards, while they also create a team identity, raise funds, hone teamwork skills, and advance respect and appreciation for STEM within the local community.

Volunteer professional mentors lend their time and talents to guide each team. It's as close to real-world engineering as a student can get. Plus, high school students gain access to exclusive scholarship opportunities from colleges, universities, and technical programs.

Each January at an event known as "Kickoff," a new, challenging game is introduced. These exciting competitions combine the practical application of science and technology with the fun, intense energy, and excitement of a championship-style sporting event. Teams are encouraged to display *Gracious Professionalism*[®], help other teams, and cooperate while competing. This is known as *Coopertition*[®].

In 2025, *FIRST* Robotics Competition is projected to reach approximately 90,000 high-school students representing approximately 3,600 teams. Teams come from nearly every state in the United States, as well as many other countries.

FIRST Robotics Competition teams will participate in 69 Regional Competitions, 103 District Competitions, and 12 District Championships. In addition, approximately 600 teams will qualify to attend the *FIRST* Championship in April 2025.

This year's game, and this manual, were presented at the 2025 *FIRST* Robotics Competition Kickoff on Saturday, January 4, 2025.

At the Kickoff, all teams:

- saw the 2025 game, REEFSCAPESM presented by Haas, for the first time,
- learned about the 2025 game rules and regulations, and
- received a set of game specific materials.

1.4 *Gracious Professionalism*[®], a *FIRST* Credo

Gracious Professionalism is part of the ethos of *FIRST*. It's a way of doing things that encourages high quality work, emphasizes the value of others, and respects individuals and the community.

Gracious Professionalism is not clearly defined for a reason. It can and should mean different things to everyone.

Some possible meanings of *Gracious Professionalism* include:

- gracious attitudes and behaviors are win-win,
- gracious folks respect others and let that respect show in their actions,
- professionals possess special knowledge and are trusted by society to use that knowledge responsibly, and
- gracious professionals make a valued contribution in a manner pleasing to others and to themselves.

In the context of *FIRST*, this means that all teams and participants should:

- learn to be strong competitors, but also treat one another with respect and kindness in the process and
- avoid leaving anyone feeling as if they are excluded or unappreciated.

Knowledge, pride, and empathy should be comfortably and genuinely blended.

In the end, *Gracious Professionalism* is part of pursuing a meaningful life. When professionals use knowledge in a gracious manner and individuals act with integrity and sensitivity, everyone wins and society benefits.

Figure 1-2 Dr. Woodie Flowers, *Gracious Professionalism* advocate and exemplar



“The FIRST spirit encourages doing high-quality, well-informed work in a manner that leaves everyone feeling valued. Gracious Professionalism seems to be a good descriptor for part of the ethos of FIRST. It is part of what makes FIRST different and wonderful.”

*- Dr. Woodie Flowers, (1943 – 2019)
Distinguished Advisor to FIRST*

It is a good idea to spend time going over this concept with your team and reinforcing it regularly. We recommend providing your team with real-life examples of *Gracious Professionalism* in practice, such as when a team loans valuable materials or expertise to another team that they will later face as an opponent in competition. Routinely highlight opportunities to display *Gracious Professionalism* at events and encourage team members to suggest ways in which they can demonstrate this quality themselves and through outreach activities.

1.5 Coopertition®

At FIRST, *Coopertition* is displaying unqualified kindness and respect in the face of fierce competition. *Coopertition* is founded on the concept and philosophy that teams can and should help and cooperate with one another even as they compete. *Coopertition* involves learning from teammates and mentors. *Coopertition* means competing always but assisting and enabling others when you can.

Message from Woodie Flowers Award Recipients

The Woodie Flowers Award is the most prestigious mentoring award in FIRST. The award recipients created an important message for all FIRST Robotics Competition teams to consider as we tackle each season.

Performing at your best is important. Winning is important. This is a competition.

However, winning with Gracious Professionalism and being proud of what you have accomplished and how you have accomplished it is more important. FIRST could create rules and penalties to cover almost any scenario or situation, but we prefer an understandable game with simpler rules that allow us to think and be creative in our designs.

We want to know that our partners and opponents are playing at their best in every MATCH. We want to know they are playing with integrity and not using strategies based on questionable behaviors.

As you create your ROBOTS and award presentations, prepare for competition and MATCH play, create and implement game strategies, and live your daily lives, remember what Woodie said time and time again, and let's 'Make your Grandmother proud.'

Woodie Flowers	Rob Mainieri (812, 64, 498,	Eric Stokely (258, 360, 2557,
Liz Calef (88)	2735, 6833)	& 5295)
Mike Bastoni (23)	Dan Green (111)	Glenn Lee (359)
Ken Patton (51, 65)	Mark Breadner (188)	Gail Drake (1885)
Kyle Hughes (27)	John Novak (16, 323)	Allen Gregory (3847)
Bill Beatty (71)	Chris Fultz (234)	Lucien Junkin (118)
Dave Verbrugge (5110, 67)	John Larock (365)	Matt Fagen (4253)
Andy Baker (3940, 45)	Earl Scime (2614)	Christine Sapio (2486)
Dave Kelso (131)	Fredi Lajvardi (842)	Mark Buckner (4265)
Paul Copioli (3310, 217)	Lane Matheson (932)	Norman Morgan (2468)
	Mark Lawrence (1816)	

1.6 Spirit of Volunteering

Message from the Global Volunteers

Welcome to the 2025 FIRST Robotics Competition – we're excited for you to discover FIRST[®] DIVESM presented by Qualcomm and REEFSCAPESM presented by Haas. We're even more excited to see what you and your team can achieve this season and at the more than 185 events worldwide this season.

FIRST is made possible by our volunteers

Volunteers are the driving force behind the delivery of all FIRST programs including the FIRST Robotics Competition. Each year it takes thousands of volunteers donating their time, energy, and enthusiasm to ensure that every FIRST Robotics Competition team has the opportunity to achieve its goals. FIRST volunteers come from a diverse set of backgrounds and are united by the same goal: to provide the best possible FIRST experience for all participating teams.

We encourage everyone in the FIRST community to join in the fun and excitement of events by participating as a volunteer.

Why Volunteer?

- Witness capable students learning and growing
- Forge meaningful friendships with other awesome volunteers
- Be part of the magic that brings events to life
- Share the wonders of FIRST with those who are yet to discover it
- Bring invaluable event experiences back to your team
- Learn and grow beyond your usual circles

FIRST Alumni and Graduating Students:

You've experienced firsthand the impact of FIRST in your life, the opportunities it has provided, and the excitement of participating. Your FIRST experience does not have to end after you graduate – being a volunteer or mentor gives you the opportunity to continue learning, growing, building a community, and having fun at FIRST events. Your experience as a student in a FIRST program is invaluable to helping ensure future students have an amazing experience. [There are volunteer roles for every skill level, background, and level of commitment](#) – everyone is welcome!

Learn more and sign up as a FIRST volunteer on the [FIRST website](#).

FIRST is about you

Volunteers eagerly donate their time and efforts to make it possible for you to participate and have fun! We strive to demonstrate the FIRST philosophies of Gracious Professionalism and Coopertition in every interaction – in return, we ask the same of you. If for any reason you feel like our volunteers could have done a better job, we want to know about it – talk to a mentor, trusted adult, other event volunteer or staff member, or report it to FIRST via customerservice@firstinspires.org.

Join us for the 2025 season and be a part of the incredible journey that is FIRST Robotics Competition! Your involvement is key to our collective success. We look forward to welcoming you!

With gratitude and excitement for what lies ahead, your 2025 Global Volunteers:

Global Field Supervisors – Ayla DeLaat & Bryan Herbst
Global FIRST Technical Advisors (FTAs) – James Cerar & Mark McLeod
Global Head Referees – Aidan Browne & Jon Zawislak
Global Judge Advisors – Cindy Stong & Allen Bancroft
Global Lead Robot Inspectors – Al Skierkiewicz & Chuck Dickerson
Global Lead Scorekeepers – Alex Herreid & Andrea “Duckie” Tribo
Global Volunteer Coordinators – Laurie Shimizu & Sarah Plemmons

1.7 This Document & Its Conventions

The 2025 Game Manual is a resource for all FIRST Robotics Competition teams for information specific to the 2025 season and the REEFSCAPE game. Its audience will find the following detail:

- a general overview of the REEFSCAPE game,
- detail about the REEFSCAPE playing FIELD,
- a description of how to play the REEFSCAPE game,
- rules (related to safety, conduct, game play, inspection, event, etc.), and
- a description of how teams advance at 2025 tournaments and throughout the season

The intent of this manual is that the text means exactly, and only, what it says. Please avoid interpreting the text based on assumptions about intent, implementation of past rules, or how a situation might be in “real life.” There are no hidden requirements or restrictions. If you've read everything, you know everything.

Specific methods are used throughout this manual to highlight warnings, cautions, key words, and phrases. These conventions are used to alert the reader to important information and are intended help teams in constructing a ROBOT that complies with the rules in a safe manner.

Links to other section headings in this manual, external articles, and rule references appear in [blue underlined text](#).

Key words that have a particular meaning within the context of the *FIRST* Robotics Competition and REEFSCAPE are defined in section [15 Glossary](#) and indicated in ALL CAPS throughout this document.

The rule numbering method indicates the section, subsection, and position of the rule within that subsection. The letter indicates the section in which the rule is published.

- Q for [Section 6.7.1 Question Box](#)
- G for [Section 7 Game Rules](#)
- R for [Section 8 ROBOT Construction Rules](#)
- I for [Section 9 Inspection & Eligibility](#)
- T for [Section 10 Tournaments](#)
- C for [Section 13 FIRST Championship Tournament](#)
- E for [Section 14 Event Rules](#)

The following digit(s) represents the subsection in which the rule can be found. The final digits indicate the rule’s position within that subsection.

Figure 1-3 Rule numbering method

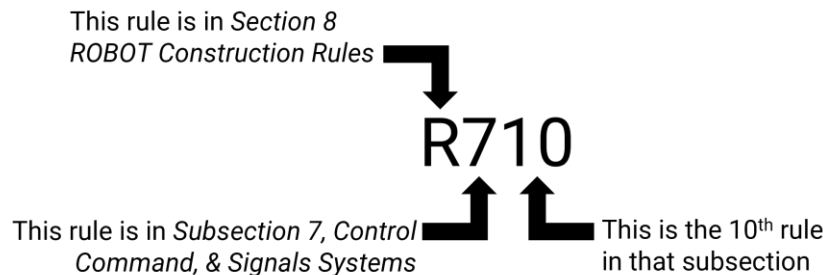

Warnings, cautions, and notes appear in blue boxes. Pay close attention to their contents as they’re intended to provide insight into the reasoning behind a rule, helpful information on understanding or interpreting a rule, and/or possible “best practices” for use when implementing systems affected by a rule.

While blue boxes are part of the manual, they do not carry the weight of the actual rule (if there is an inadvertent conflict between a rule and its blue box, the rule supersedes the language in the blue box).

Imperial dimensions are followed by comparable metric dimensions in parentheses to provide metric users with the approximate size, mass, etc. Metric conversions for non-rules (e.g. dimensions) round to the nearest whole unit, e.g. “17 in. (~43 cm)” and “6 ft. 4 in. (~193 cm).” Metric conversions in rules round such that the metric dimension is compliant with the rule (i.e. maximums round down, minimums round up). The metric conversions are offered for convenient reference only and do not overrule or take

the place of the imperial dimensions presented in this manual and the official drawings (i.e. dimensions and rules will always defer to measurements using imperial units).

Rules include colloquial language, also called headlines, in an effort to convey an abbreviated version of the rule or rule set. There are two versions of headline formatting. Evergreen rules, or rules which are expected to go relatively unchanged from season to season, are indicated with a leading asterisk and their rule number and headline are presented in **bold green text**. “Relatively unchanged” means that the overall intent and presence of the rule from season to season is constant, but game specific terms may be updated as needed (e.g. changing Power Cells to ALGAE in a rule about what COACHES may not contact during a MATCH). These rules also start their respective section, so their rule number is not expected to change from season to season. All other rule headlines use **bold blue text**. Any disagreement between the specific language used in the rules and the colloquial language is an error, and the specific rule language is the ultimate authority. If you discover a disparity, please let us know at customerservice@firstinspires.org and we will correct it.

Team resources that aren’t generally season specific (e.g., what to expect at an event, communication resources, team organization recommendations, ROBOT transportation procedures, and award descriptions) can be found on the FIRST Robotics Competition website.

1.8 Translations & Other Versions

The REEFSCAPE manual is originally and officially written in English and is occasionally translated into other languages for the benefit of FIRST Robotics Competition teams whose native language may not be English. These assets are posted on the

A text-based English version is provided only for use with assistive devices on the [Translated Manuals page](#). This document is locked for editing and has a watermark applied to indicate that it should not be copied. If you have any questions on the document, please contact the FIRST Robotics Competition Team Advocate at frcteamadvocate@firstinspires.org.

In the event that a rule or description is modified in an alternate version of this manual, the English pdf version as published on the [REEFSCAPE - Season Materials web page](#) is the commanding version.

1.9 Team Updates

Team Updates are used to notify the FIRST Robotics Competition community of revisions to the official season documentation (e.g. the manual, drawings, etc.) or important season news. Team Update posts are scheduled as follows:

- each Tuesday and Friday, starting on the first Tuesday after Kickoff and ending on the Tuesday prior to Week 1 events
- each Tuesday, starting Week 1 and ending the week of the final District Championship events.

Team Updates are posted on the [REEFSCAPE - Season Materials web page](#) and are generally posted before 5 pm, Eastern.

Generally, Team Updates follow the following convention:

- Additions are highlighted in yellow. **This is an example.**
- Deletions are indicated with a strikethrough. ~~This is an example.~~

1.10 Question and Answer System

The [Question and Answer System \(Q&A\)](#) is a resource for clarifying the [2025 REEFSCAPE Game Manual](#), [Awards webpages](#), [official FIELD drawings](#), and/or [FIRST Robotics Competition District and Regional Events web page](#) content. Teams can search for previously asked questions and responses or pose new questions. Questions can include examples for clarity or reference multiple rules to understand the relationships and differences between them.

The Q&A opens on January 8, 2025, 12:00 PM Eastern. Details on the Q&A can be found on [the REEFSCAPE - Season Materials web page](#). The Q&A may result in revisions to the text in the official manuals (which are communicated using the process described in Team Updates).

The responses in the Q&A do not supersede the text in the manual, although every effort will be made to eliminate inconsistencies between the two. While responses provided in the Q&A may be used to aid discussion at each event, per section [9 Inspection & Eligibility](#) and section [6.7 Head REFEREE and FTA Interaction](#), REFEREES and INSPECTORS are the ultimate authority on rules. If you have concerns about enforcement trends by volunteer authorities, please notify FIRST at customerservice@firstinspires.org.

The Q&A is not a resource for firm predictions on how a situation will play out an event. Questions about the following will not be addressed:

- rulings on vague situations,
- challenging decisions made at past events, or
- design reviews of a ROBOT system for legality.

Weak questions are overly broad, vague, and/or include no rule references. Some examples of questions that will not be answered in the Q&A are:

- Is this part/design legal?
- How should the REFEREE have ruled when this specific game play happened?
- Duplicate questions
- Nonsense questions

Good questions ask generically about features of parts or designs, gameplay scenarios, or rules, and often reference one or more relevant rules within the question. Some examples of questions that will likely be answered in the Q&A are:

- A device we are considering using on the ROBOT comes with purple AWG 40 wire, does this comply with R?? and R??
- We're not sure how to interpret how Rule G?? applies if blue ROBOT A does X and red ROBOT B does Y, can you please clarify?
- If a ROBOT does this specific action, is it doing what this defined term is describing?

Questions from "FRC 99999" represent content asked by key volunteers (e.g., REFEREES, INSPECTORS, etc.), answered by FIRST, and are considered relevant to teams.



2 **FIRST Season Overview**



Beneath the ocean's surface lies our planet's most complex ecosystems, full of life and potential for exploration and learning, where each inhabitant has a role to play in building a thriving environment.

During the 2024-2025 **FIRST®** season, **FIRST® DIVESM** presented by Qualcomm, teams will use their STEM and collaboration skills to explore life beneath the surface of the ocean. Along the way, we'll uncover the potential in each of us to strengthen our community and innovate for a better world with healthy oceans.



3 Game Sponsor Recognition

Thank you to the 2025 FIRST® Robotics Competition season presenting sponsor, the [Gene Haas Foundation](http://www.genehaas.com).



4 Game Overview

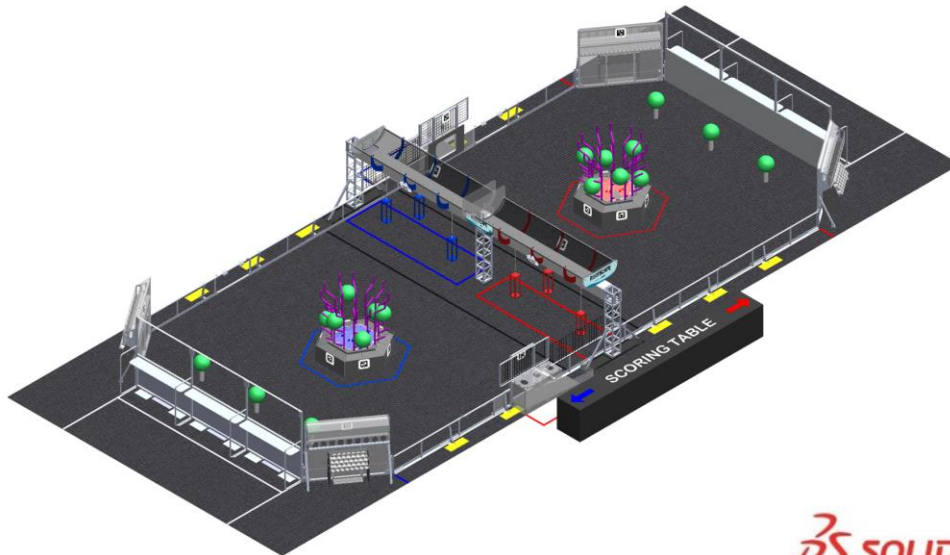

In REEFSCAPESM presented by Haas, two competing alliances are invited to score coral, harvest algae, and attach to the barge before time runs out. Alliances earn additional rewards for meeting specific scoring thresholds and for cooperating with their opponents.

During the first 15 seconds of the match, robots are autonomous. Without guidance from their drivers, robots leave their starting zone, score coral on the reef, harvest algae from the reef, and collect and score additional coral.

During the remaining 2 minutes and 15 seconds, drivers control their robots. Robots collect coral from human players at their coral station and score them on the reef. To unlock all scoring locations on the reef, robots must dislodge algae from the reef and either score it in the barge or deliver it to the human player through the processor.

A human player can then deliver the algae to the barge. If at least two algae are scored in the processor by each alliance, both alliances earn a *Cooperation* Point (which influences their rank in the tournament) and lowers the requirements for a ranking point.

As time runs out, robots prepare to return to the surface with their algae by grabbing onto their cages and parking under the barge.

The alliance that earns the most points wins the match!



5 ARENA

The ARENA includes all elements of the game infrastructure that are required to play REEFSCAPESM presented by Haas: the FIELD, SCORING ELEMENTS, queue area, team media area, designated TECHNICIAN area, and all equipment needed for FIELD control, ROBOT control, and scorekeeping.

Figure 5-1 REEFSCAPE ARENA (queue area, TECHNICIAN area, and media area not pictured)

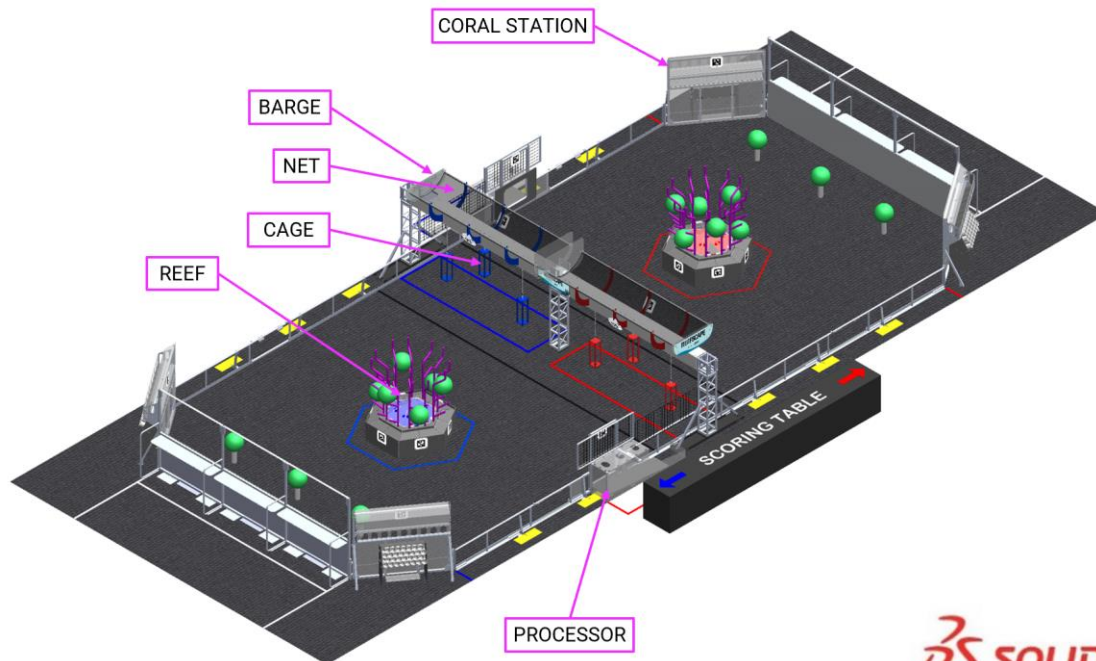

The ARENA is modular and assembled, used, disassembled, and shipped many times during the competition season. It undergoes wear and tear. The ARENA is designed to withstand rigorous play and frequent shipping. Every effort is made to ensure that ARENAS are consistent from event to event. However, ARENAS are assembled in different venues by different event staff and some small variations occur. For details regarding assembly tolerances, please refer to the [2025 ARENA Layout and Marking Diagram](#). Successful teams will design ROBOTS that are insensitive to these variations.

Illustrations included in this section are for a general visual understanding of the REEFSCAPE ARENA, and dimensions included in the manual are nominal. Please refer to the official drawings for exact dimensions, tolerances, and construction details. The official drawings, CAD models, and drawings for low-cost versions of important elements of the REEFSCAPE FIELD are posted on [the REEFSCAPE Playing FIELD web page](#) on the FIRST website.

5.1 FIELD

Each FIELD for REEFSCAPE is an approximately 26 ft. 5 in. (~805 cm) by 57 ft. 6 $\frac{3}{8}$ in. (~1 755 cm) carpeted area bounded by inward facing surfaces of the ALLIANCE WALLS, CORAL STATIONS, PROCESSORS and PROCESSOR openings, and guardrails.

Figure 5-2 FIELD boundary in pink

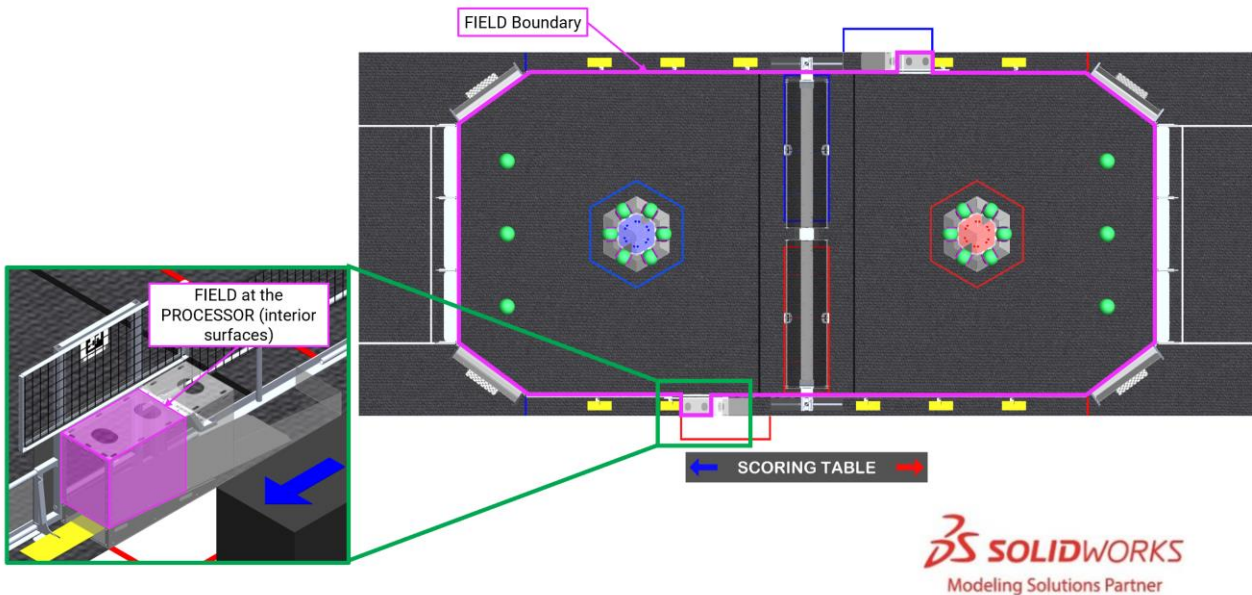

The FIELD is populated with and surrounded by the following elements:

- 1 REEF per ALLIANCE,
- 1 PROCESSOR per ALLIANCE,
- 2 CORAL STATIONS per ALLIANCE, and
- 1 BARGE which consists of 3 CAGES and 1 NET for each ALLIANCE.

The surface of the FIELD is low pile carpet, Shaw Floors, Philadelphia Commercial, Neyland II 20, "66561 Medallion." Neyland II carpet is not available for purchase, and the closest equivalent is [Shaw, Philadelphia Brand, Profusion 20, Style 54933](#); see results from FIRST's evaluation in [this blog post](#).

Carpet edges and seams are secured with 3M™ Premium Matte Cloth (Gaffers) Tape GT2, GT3 or comparable Gaffer's Tape. Tears, rips, and damage to the carpet may be repaired with the same styles of tape and ROBOTS must be prepared to operate on surfaces made of carpet, tape, or combinations of both materials as repairs are made through the course of competition.

Guardrails form the long edges of the FIELD. Guardrails are a 1 ft. 8 in. (~51 cm) tall system of transparent polycarbonate supported on the top and bottom by aluminum extrusion. There are 4 gates in the guardrail that allow access to the FIELD for placement and removal of ROBOTS. The gate passthrough, when open, is 3 ft. 2 in. (~97 cm) wide. Gates are closed and shielded during the MATCH.

Figure 5-3 Gate locations

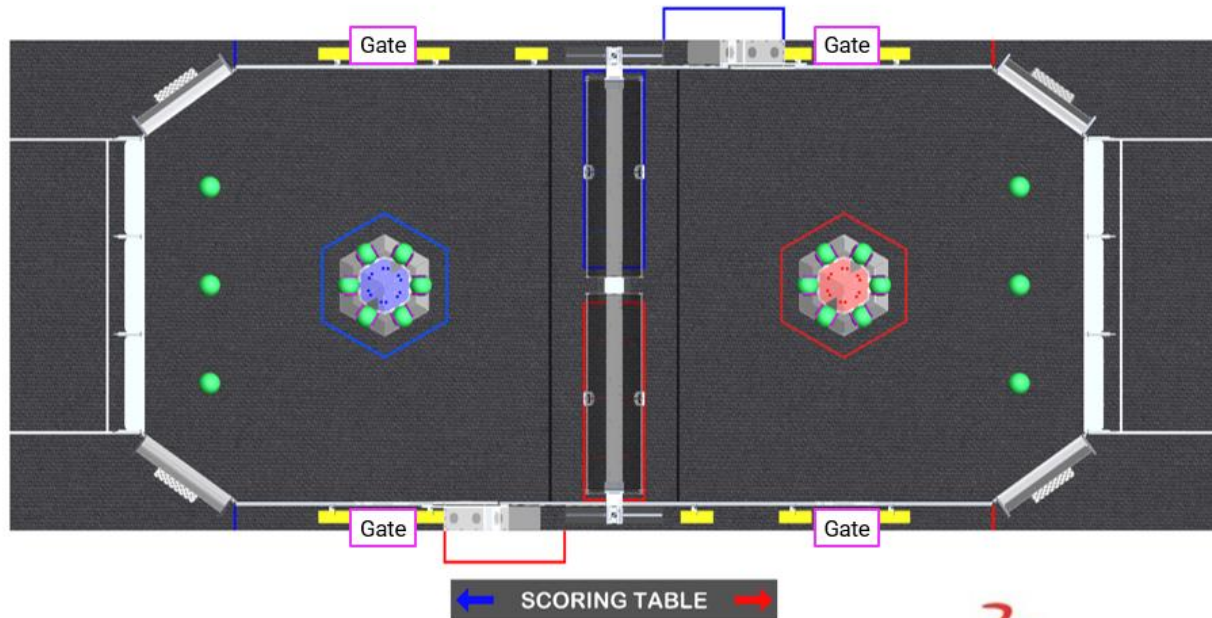

There are 2 versions of guardrails and DRIVER STATIONS used for competitions. 1 design is reflected in the [2025 Official FIRST FIELD Drawings & Models](#). The other is designed and sold by AndyMark. While the designs are slightly different, the critical dimensions, performance, and expected user experience between them are the same unless otherwise noted. Detailed drawings for the AndyMark design are posted on the [AndyMark website](#). All illustrations in this manual show the traditional FIELD design.

5.2 Areas, Zones, & Markings

FIELD areas, zones, and markings of consequence are described below. Unless otherwise specified, the tape used to mark lines and zones throughout the FIELD is 2 in. (~51 mm) [3M™ Premium Matte Cloth \(Gaffers\) Tape \(GT2\)](#), [ProGaff® Premium Professional Grade Gaffer Tape](#), or comparable gaffers tape.

Figure 5-4 Areas, markings, and zones

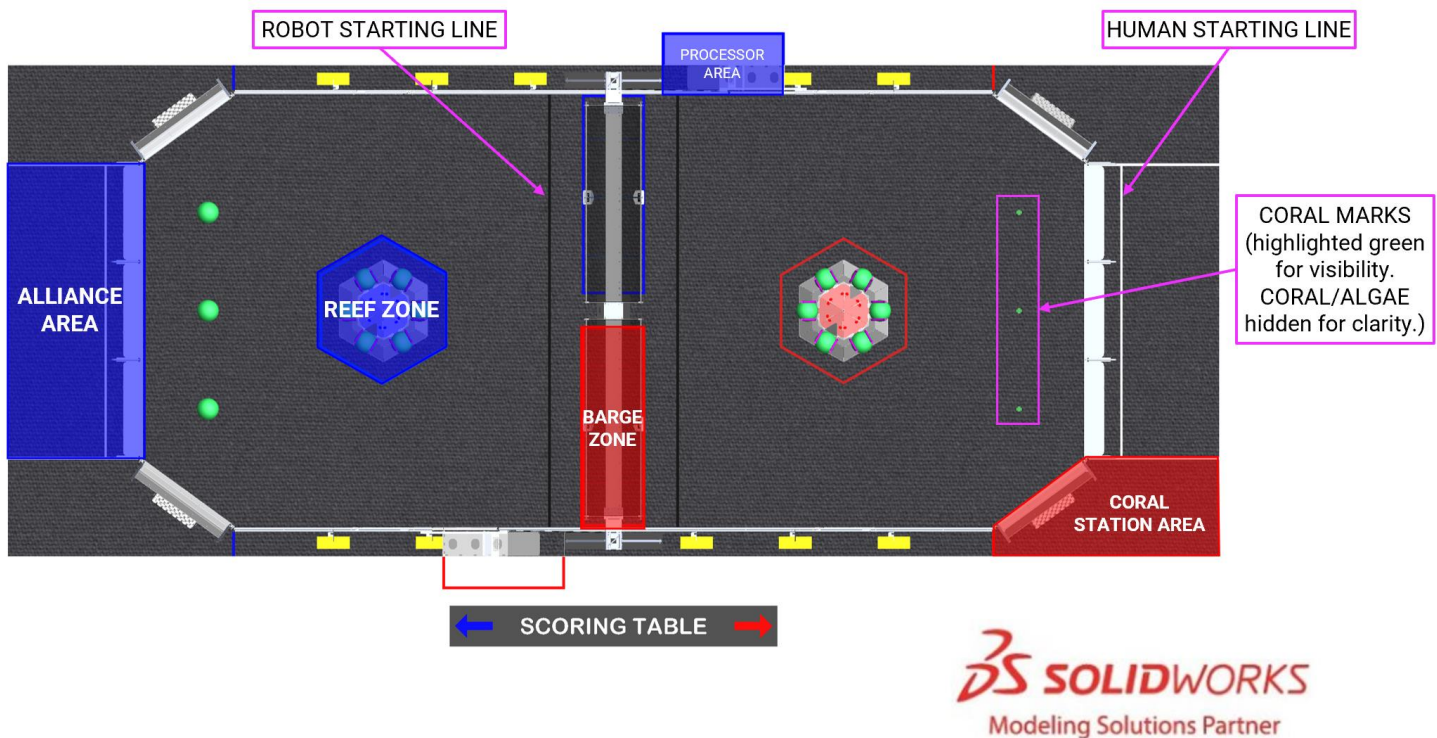

- **ALLIANCE AREA:** a 18 ft. 1¼ in. wide by 13 ft. 10⅜ in. deep (~552 cm by 423 cm) infinitely tall volume formed by, and including the ALLIANCE WALL, CORAL STATION AREAS, the edge of the carpet, and white colored tape perpendicular to the Driver Stations.
- **BARGE ZONE:** a 3 ft. 10 in. deep by 12 ft. 2½ in. long (~117 cm by 372 cm), infinitely tall, 4-sided volume surrounding the ALLIANCE’S half of the BARGE. It is bounded by and includes the ALLIANCE-colored tape.
- **CORAL MARK:** 1 of 6 4 in. by 4 in. (~102 mm by 102 mm) “+” marks used to identify placement of CORAL before the MATCH. Marks are made with black tape.
- **CORAL STATION AREA:** a 5 ft. 10⅞ in. wide by 13 ft. 10⅜ in. ft deep (~180 cm by 423 cm) infinitely tall volume bounded by the CORAL STATION, edge of carpet, and ALLIANCE and white colored tape.
- **HUMAN STARTING LINE:** a white line spanning the ALLIANCE AREA between the CORAL STATION AREAS that is parallel to and located 2 ft. (~61 cm) from the bottom square tube of the ALLIANCE WALL to the near edge of the tape.
- **PROCESSOR AREA:** a 3 ft. 7⅞ in. wide by 7 ft. 6 in. deep (~110 cm by 229 cm) infinitely tall volume formed by, and including, the ALLIANCE colored tape, guardrail, and the PROCESSOR wall.
- **REEF ZONE:** an infinitely tall 6-sided, 7 ft. 9½ in. wide (face to face) (~237 cm), volume surrounding the ALLIANCE’S REEF. It is bounded by and includes the ALLIANCE-colored tape.
- **ROBOT STARTING LINE:** a black line that spans the width of the FIELD between each REEF and the BARGE. It is positioned such that it is 7 ft. 4 in. (~224 cm) from the REEF.

5.3 REEF

Figure 5-5 REEF

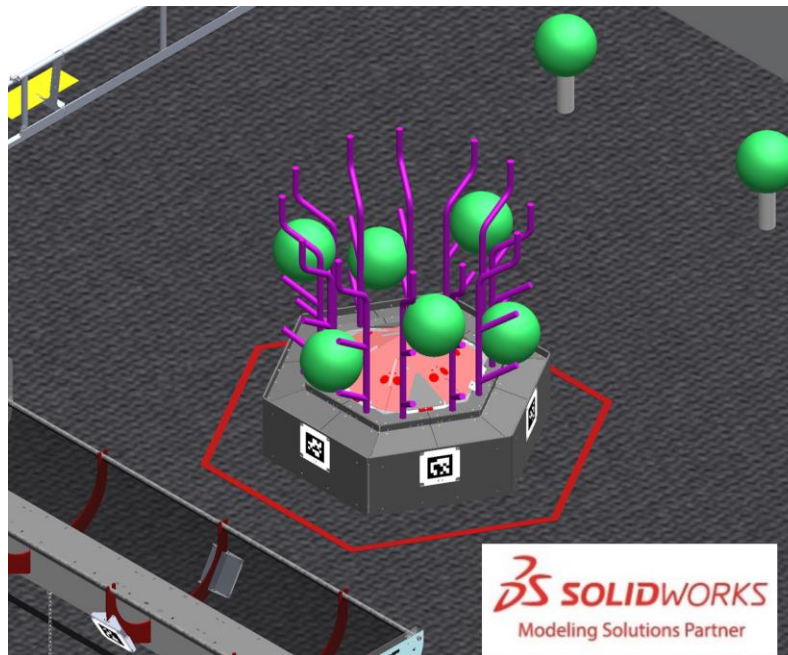

A REEF is 1 of 2 5 ft. 5 ½ in. (~166 cm) hexagonal structures with BRANCHES that extend from each side where CORAL are scored. Each ALLIANCE has a dedicated REEF centered between each guardrail and located 12 ft. away from the ALLIANCE WALL. Each REEF has 4 levels to score on Level 1 (L1), Level 2 (L2), Level 3 (L3), and Level 4 (L4).

Figure 5-6: Scoring Level Locations (L1-L4)

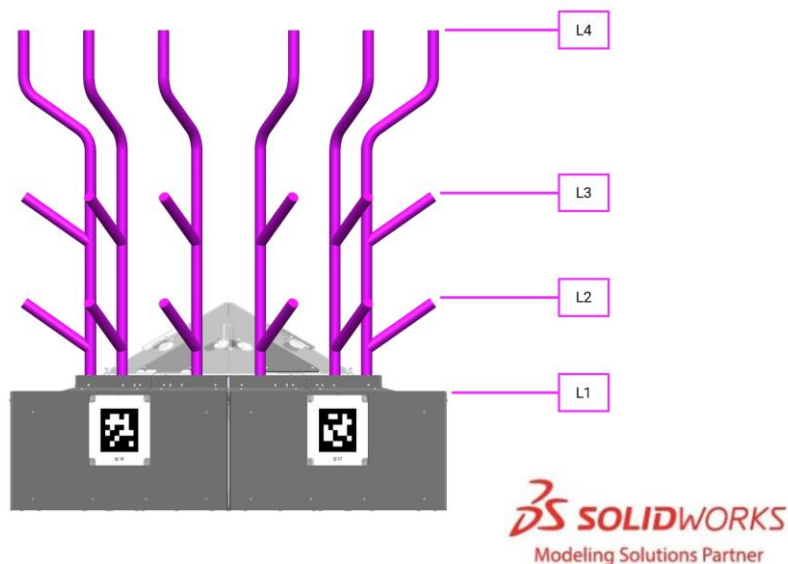

The base of each REEF has a trough (L1) into which ROBOTS can score CORAL. The trough includes the angled and vertical surfaces, as well as the top of the front edge as shown in [Figure 5-7](#). The front edge of the trough is 1 ft. 6 in. (~46 cm) off the carpet.

Figure 5-7: Trough Surfaces

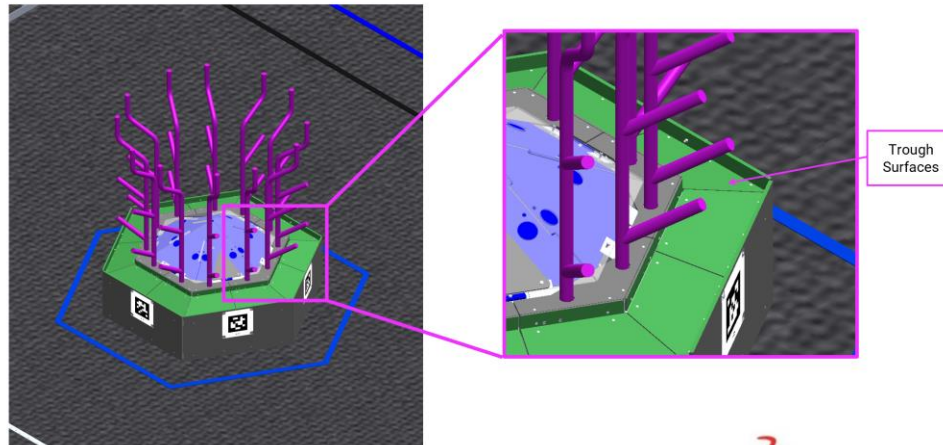

Vertical pipes extend up from the base, and pipes on the same face are 1 ft. 1 in. (~33 cm) apart (center to center). The pipes are made out of 1-¼ in. Schedule 40 Steel. Each pipe has 3 BRANCHES which are angled or compound extensions from the REEF vertical pipes.

L2 is the 12 lowest level BRANCHES and are angled up at 35°. The highest point of the L2 BRANCH is 2 ft. 7⅞ in. (~81 cm) from the carpet and is inset 1⅝ in. (~41 mm) from the REEF base.

L3 is the 12 mid-level BRANCHES and are angled up at 35°. The highest point of the L3 BRANCH is 3 ft. 11⅝ in. (~121 cm) from the carpet and is inset 1⅝ in. (~41 mm) from the REEF base.

L4 is the 12 highest-level BRANCHES and they are vertical. The highest point of the L4 BRANCH is 6 ft. (~183 cm) from the carpet and is inset 1⅞ in. (~29 mm) from the REEF base.

For scoring purposes, the BRANCHES of the REEF are tracked in FMS as follows:

Figure 5-8: Reef Scoring Location Tracking

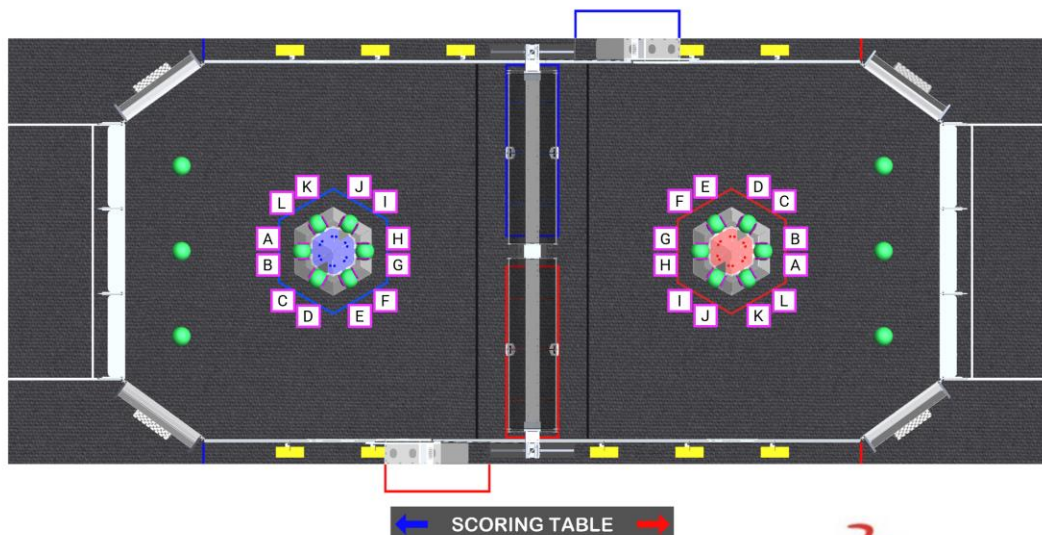

5.4 BARGE

Figure 5-9 BARGE

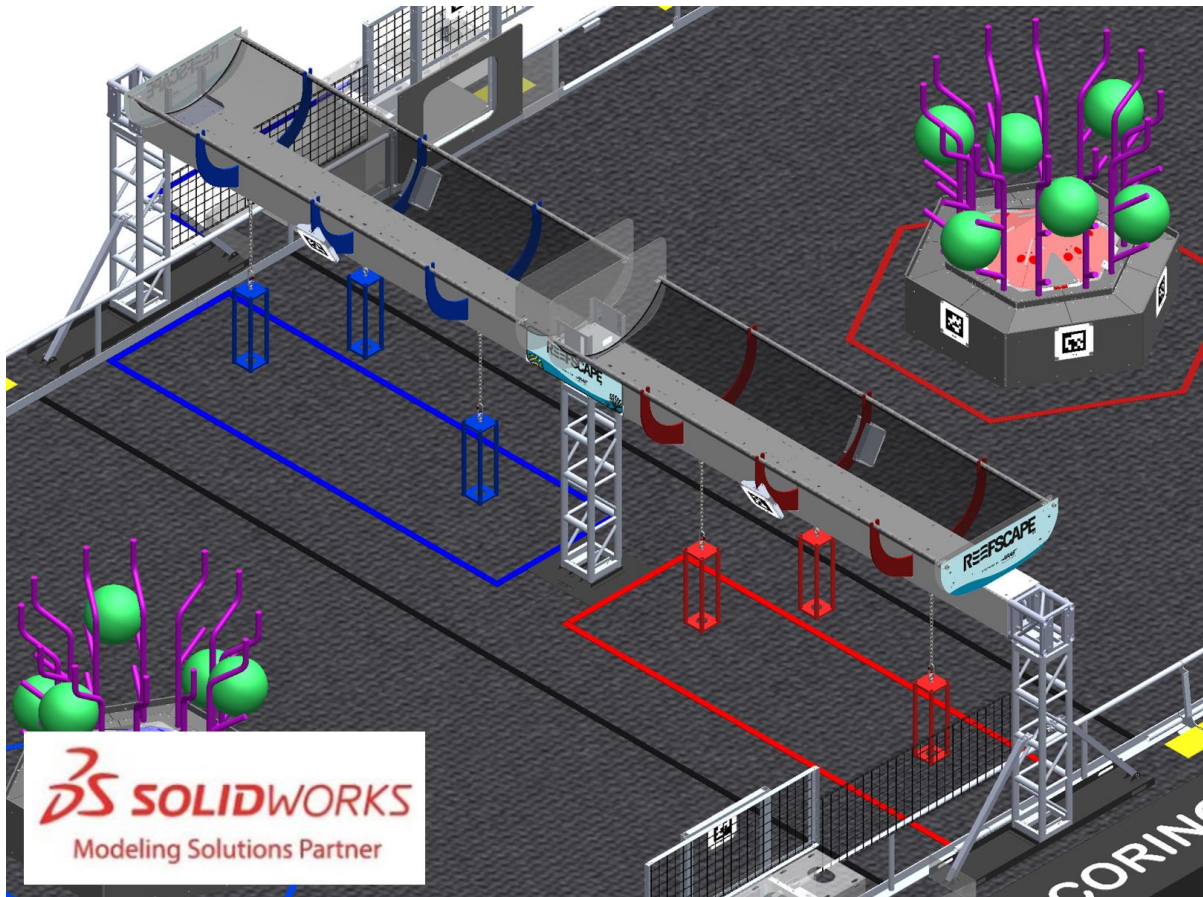

The BARGE is a 29 ft. 2 in. (889 cm) wide, 3 ft. 8 in. (~112 cm) deep, and 8 ft. 5 in. (~257 cm) tall structure that spans the center of the FIELD. It is made of truss structure supported by legs just outside the guardrail. The BARGE includes 6 CAGES, a red and blue NET, and all structure supporting CAGES and NETS. The horizontal truss structure is 5 ft. 2 in. (~157 cm) above the carpet and is supported in the center of the FIELD by vertical truss and supporting materials. The BARGE has three CAGE locations on each side located 3 ft. 5½ in., 7 ft. ¾ in., 10 ft. 7¾ in. (~105 cm, ~214 cm, ~324 cm) from mid field to the center of the CAGE.

The BARGE has three segments of lights on each side of the truss which indicate progression toward and completion of the *Coopertition* Bonus and the final 20 seconds in the match. One segment will light up each time an ALGAE is scored in the PROCESSOR. Once each alliance has scored two ALGAE all six segments will illuminate. The lights will flash to indicate that there are 20 seconds left in the match.

5.4.1 CAGE

Figure 5-10 Shallow (left) and Deep (right) staged CAGES

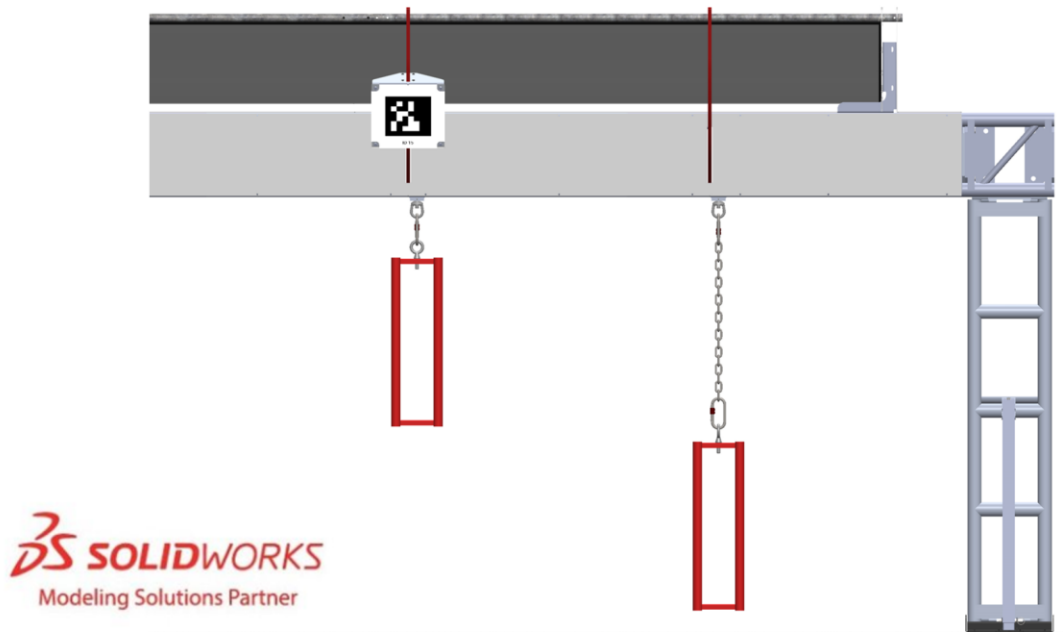

CAGES are 2 ft. tall and 7³/₈ in. wide (outside dimension) (~61 cm tall and ~19 cm wide) rectangular structures. Each CAGE is a welded structure made of 4 steel 1-³/₈ in. Schedule 40 pipes, a bottom plate, a top plate, and an eyebolt with fastening hardware. CAGES are suspended from the truss structure in specific locations as shown in [Figure 5-9](#) and hang at shallow or deep positions according to the corresponding team's selection (see section [6.3.5 CAGES](#) for details) such that the bottom of the cage is 3¹/₂ in. (~89 mm) and 2 ft. 5³/₈ in. (~75 cm) from the carpet respectively. Deep CAGES are suspended using chain that is 19 links of [1/4-in. Grade 43 zinc plated chain](#).

ANCHORS are a collection of surfaces at the top of the CAGE and chain assembly that include the following items and as shown in [Figure 5-11](#):

- A. the top surface of the CAGE top plate,
- B. the chain,
- C. both carabiners,
- D. the portion of the eye bolt extending above the CAGE top plate,
- E. the eye nut attached to the BARGE,
- F. the upper end surfaces of the CAGE pipes, and
- G. the inside surfaces of the CAGE pipes.

Figure 5-11: ANCHOR Surfaces

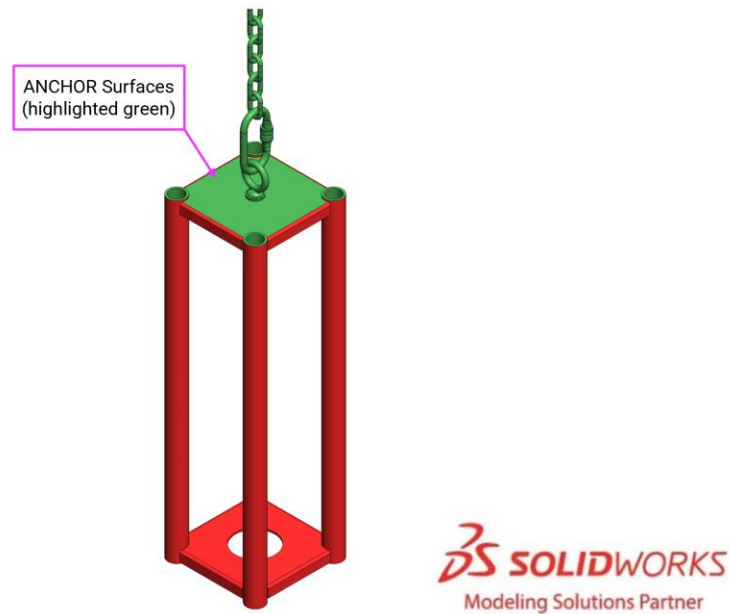

5.4.2 NET

Figure 5-12 NET

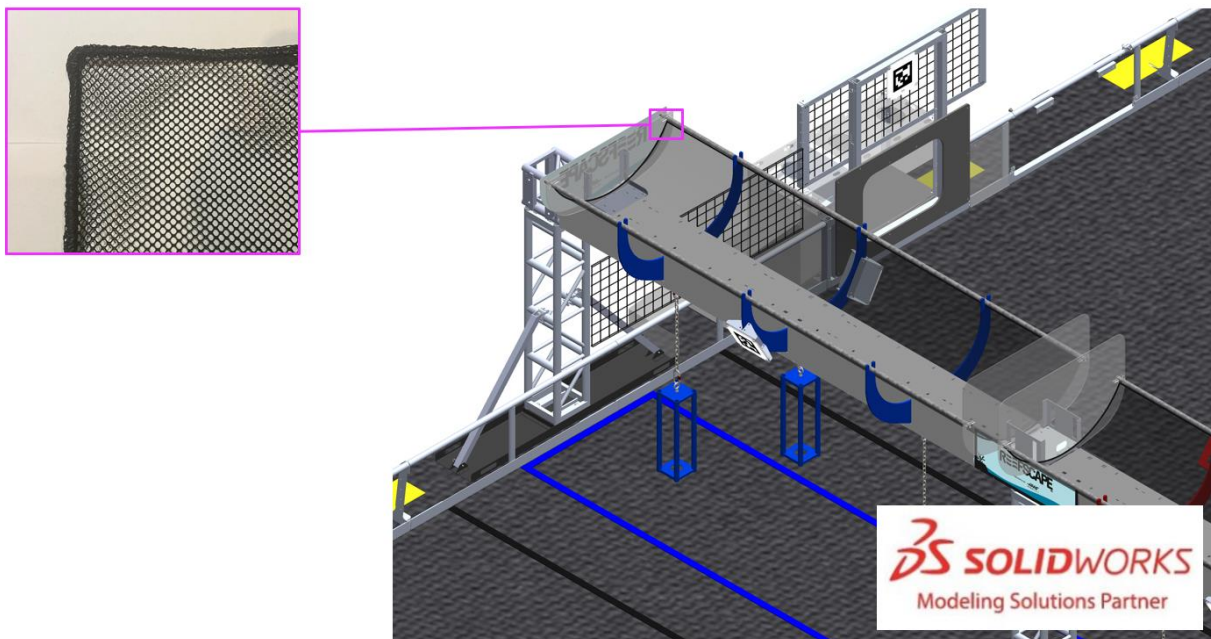

A NET is a goal in which an ALLIANCE scores ALGAE. The NET is ¼ in. (~6 mm) knit polyester mesh, 4 ft. (~122 cm) wide by 12 ft. (~366 cm) long with a sewn cord border. It is available for purchase from AndyMark, [am-5522](https://www.andymark.com/am-5522). It is suspended from the top of the BARGE such that its lowest point hangs 6 ft. 4 in. (~193 cm) above the FIELD carpet. There is a NET for the Blue ALLIANCE and for the Red ALLIANCE.

5.5 PROCESSOR

Figure 5-13: PROCESSOR

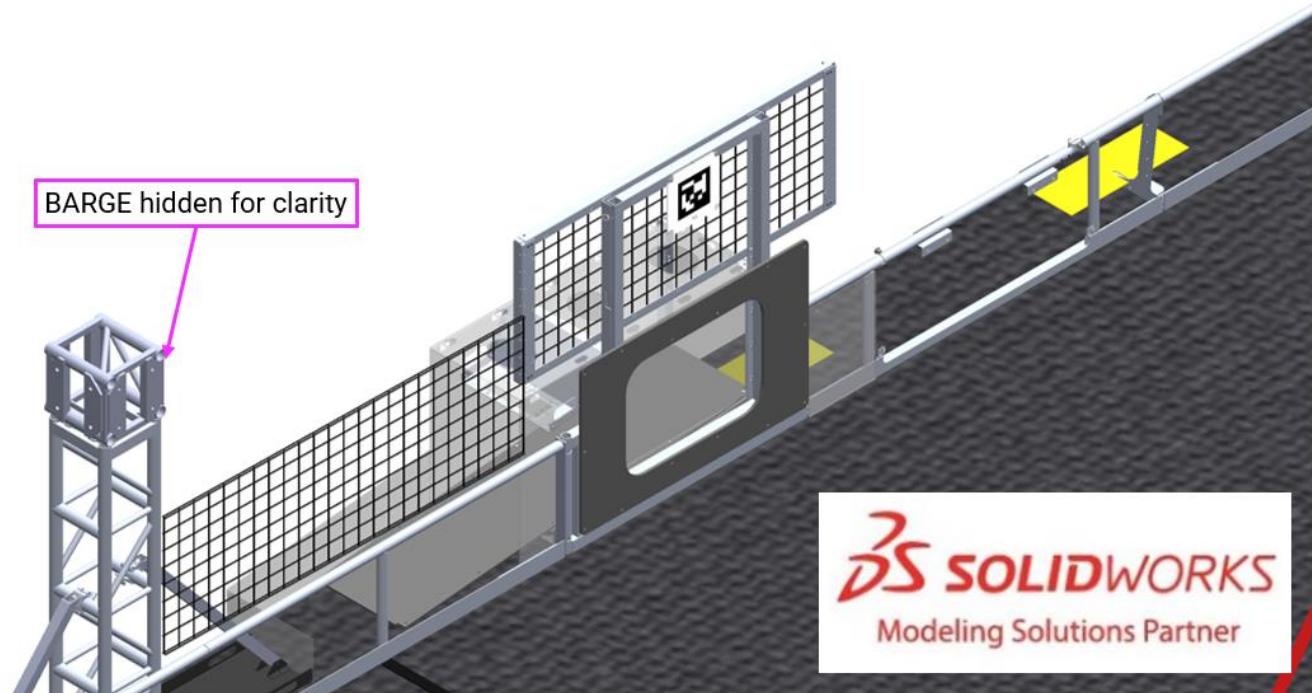

A PROCESSOR is a goal into which an ALLIANCE scores ALGAE. There is 1 PROCESSOR per ALLIANCE. The PROCESSOR is integrated into the guardrail near the ALLIANCE'S REEF ZONE and adjacent to the opponent's PROCESSOR AREA. Each PROCESSOR has a rectangular opening through which ROBOTS score ALGAE which is 2 ft. 4 in. wide (~71 cm), 1 ft. 8 in. tall (~51 cm), and 7 in. (~18 cm) from the carpet.

Once an ALGAE passes through the PROCESSOR, it rolls past a scoring sensor array and into the opponent's PROCESSOR AREA. To keep the PROCESSOR clear for scoring, the HUMAN PLAYER can shift scored ALGAE on top of the PROCESSOR where there are designated ALGAE holders.

5.6 ALLIANCE WALL

Figure 5-14: Red ALLIANCE WALL (highlighted in red)

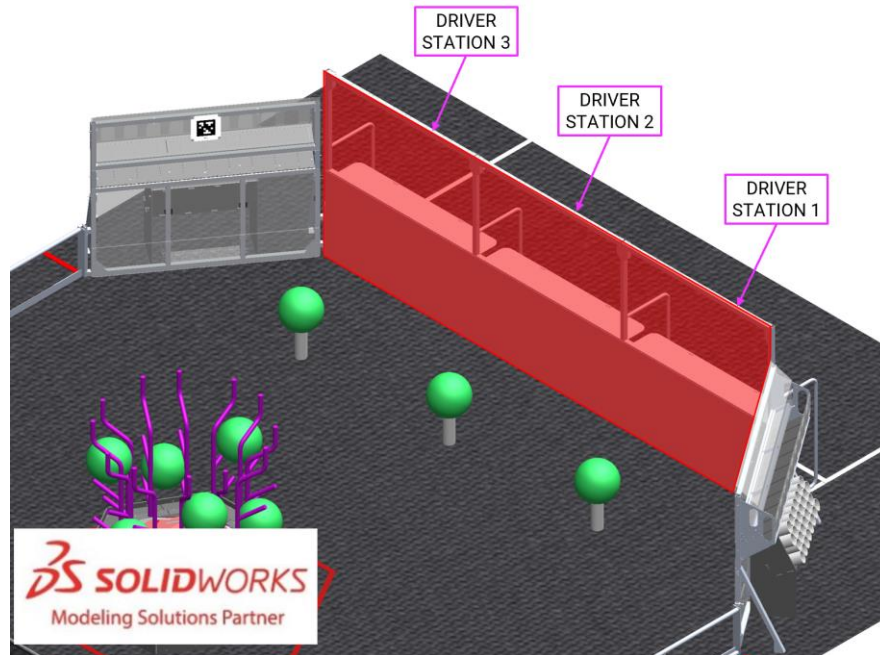

The ALLIANCE WALL separates ROBOTS from DRIVE TEAM members in the ALLIANCE AREA. It consists of 3 DRIVER STATIONS.

5.6.1 DRIVER STATIONS

Figure 5-15 DRIVER STATION (ALLIANCE AREA perspective and FIELD perspective)

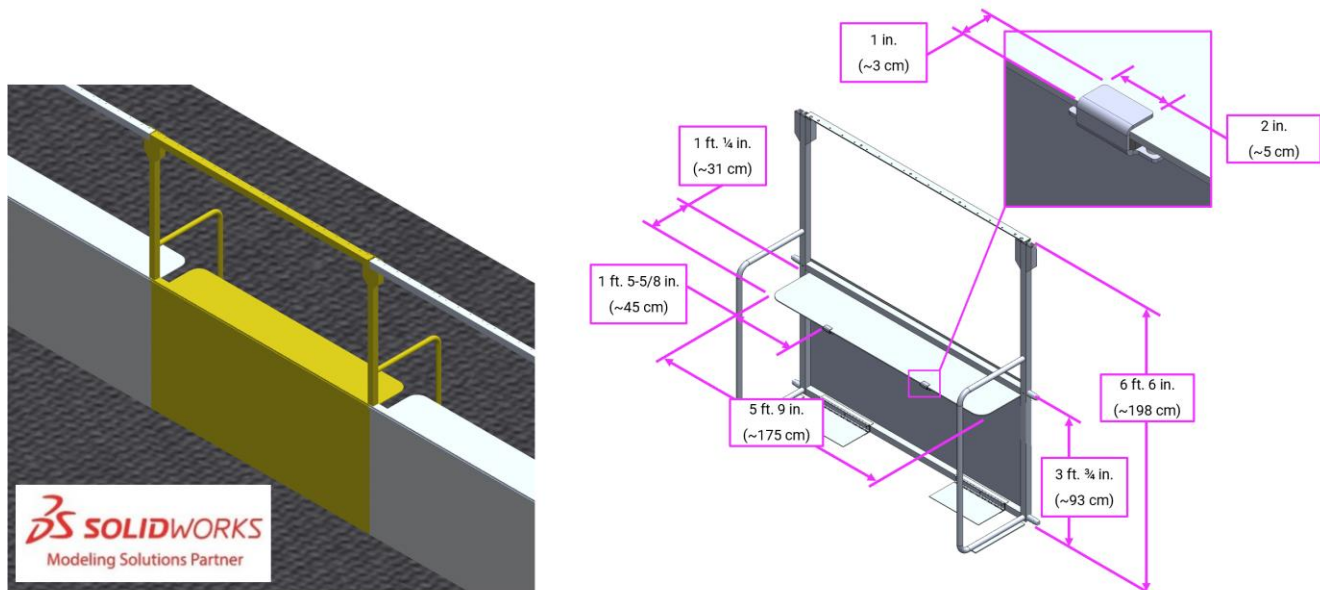

A DRIVER STATION is 1 of 3 assemblies within an ALLIANCE WALL behind which a DRIVE TEAM operates their ROBOT. Each DRIVER STATION is made from a 3 ft. $\frac{3}{4}$ in. (~93 cm) tall diamond plate base topped with a 3 ft. 6 in. (~107 cm) tall transparent plastic sheet and a top rail. An aluminum shelf is attached to each DRIVER

STATION to support an OPERATOR CONSOLE. The shelf is 5 ft. 9 in. (~175 cm) wide and 1 ft. ¼ in. (~31 cm) deep. There is a 4 ft. 6 in. (~137 cm) long by 2 in. (nominal) wide strip of hook-and-loop tape (“loop” side) along the center of the support shelf that may be used to secure the OPERATOR CONSOLE to the shelf. The shelf also includes two clips to hold the shelf in place with a 1 in. (~25 mm) by 2 in. (~51 mm) thick tab that sits on the top surface of the shelf.

There may be a ramp available at events for DRIVE TEAMS with limited mobility. It is designed to allow an individual using a wheelchair to access the DRIVER STATION shelf and/or see onto the FIELD; however, this accommodation is available to anyone who has a wheelchair or other physical disability that obstructs their view of the FIELD. Teams should speak to the FTA before MATCHES begin to ensure that it is available for each of the team’s MATCHES.

This ramp is available at many Regional and District events. For questions, please connect with the local [Program Delivery Partner](#).

Each DRIVER STATION contains the following elements for DRIVE TEAMS:

- 1 Ethernet cable: attaches to the Ethernet port of the OPERATOR CONSOLE and provides connectivity to the FIELD Management System (FMS)
- 1 120VAC NEMA 5-15R power outlet (i.e. standard US outlet): located on each DRIVER STATION shelf and protected by its own 2-Amp circuit breaker. It can be used to power the OPERATOR CONSOLE. DRIVE TEAMS are responsible for monitoring their power consumption as a tripped breaker in the outlet does not constitute an ARENA FAULT. For some events in regions that don’t use NEMA 5-15 shaped outlets, event organizers may install appropriate plug adapters to be used throughout the event.
- 1 Emergency Stop (E-Stop) button: located on the left side of the DRIVER STATION shelf and is used to deactivate a ROBOT in an emergency
- 1 Autonomous Stop (A-Stop) button: located on the right side of the DRIVER STATION shelf and is used to DISABLE a ROBOT during AUTO
- 1 team sign: located at the top of each DRIVER STATION. The FIELD facing side of the sign displays the team number in the ALLIANCE color. The ALLIANCE AREA side of the sign displays the following information in red:
 - Pre-MATCH: team number and ROBOT connection state
 - During the MATCH:
 - remaining MATCH period time,
 - MATCH scores, and
 - progress towards the CORAL RP threshold (n/a during the Playoff Tournament).

Figure 5-16 Back of team sign



- 1 timer (in DRIVER STATION 2 only): displays the official time remaining in the MATCH period on the FIELD-facing side (in white) and a more detailed breakdown of CORAL scored on each level of the REEF on the TEAM-facing side. (in red).

Figure 5-17 Back of timer



- 1 team LED stack: indicates ALLIANCE color, ROBOT status, E-Stop and A-Stop status, and is centered at the top of each DRIVER STATION.

The stack includes 2 identical ALLIANCE-colored ROBOT status LEDs above a third amber A-stop/E-stop LED. LED states are as follows:

- o ROBOT status LEDs
 - Solid: indicates that the ROBOT is connected and enabled. This only happens during a MATCH.
 - Blinking: indicates that either the FMS is preset for the MATCH and the ROBOT is not connected yet, or it's during a MATCH and the corresponding ROBOT is BYPASSED, has lost connectivity, or the E-stop was pressed.
 - Off: indicates that the ROBOT is linked and DISABLED prior to the start of the MATCH. This light is also off, regardless of ROBOT connection status, after the MATCH has concluded.
- o A-Stop/E-stop LED
 - Solid: the ROBOT is DISABLED due to a press of the team E-stop button, the FIELD E-stop button, or by the scorekeeper via the FMS.
 - Blinking: the ROBOT is DISABLED for the remainder of AUTO due to a press of the team A-Stop button.
 - Off: the ROBOT is not DISABLED by the FIELD.
- FMS hardware and wiring: mostly located below shelves in the 2 DRIVER STATIONS closer to the scoring table.

5.6.2 CORAL STATION

Figure 5-18 CORAL STATION

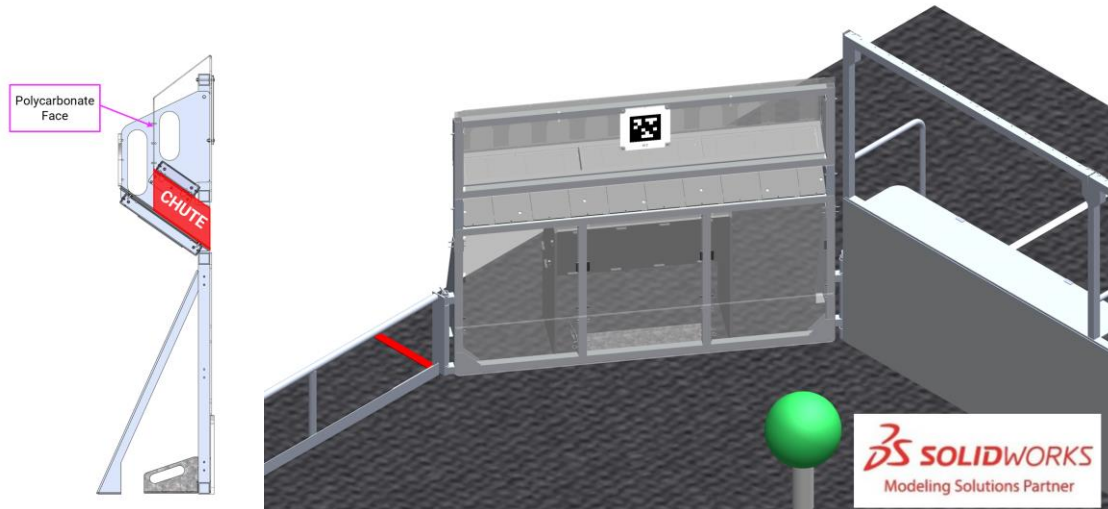

A CORAL STATION is an assembly through which HUMAN PLAYERS feed CORAL into the FIELD. There are 4 CORAL STATIONS, 1 in each corner of the FIELD connecting the guardrail to the ALLIANCE WALL. Each CORAL STATION has a 6 ft. 4 in. wide by 7 in. tall (~193 cm wide by ~18 cm tall) opening through which CORAL passes to the FIELD; the bottom of the opening is 3 ft. 1½ in. (~95 cm) from the carpet. A 55° sloped tunnel, called the CHUTE, leads to the opening in the CORAL STATION.

There are 2 stools available at events for DRIVE TEAMS to use. Each stool is 1 ft. 11 in. (~58 cm) wide by 1 ft. 1½ in. (~34 cm) deep, 6¼ in. (~16 cm) tall, and rated for 300 lbs. (~136 kg).

It is specially intended to allow individuals who are shorter, better sightlines onto the FIELD; however, this accommodation is available to anyone who has another physical disability that obstructs their view of the FIELD.

Only 2 stools are available, and priority will be given to those with the biggest need. Teams should speak to the FTA before MATCHES begin to request that it is available for each of the team's MATCHES. Teams may also purchase their own ([Item Number: 779ac01stpm](#)) or bring an equivalent (e.g. not foldable and similar dimensions) version to the event to guarantee use for every match.

This stool is available at all events within the US & Canada and equivalents are available at international events. For questions, please connect with the local [Program Delivery Partner](#).

5.7 SCORING ELEMENTS

SCORING ELEMENTS are items that teams use to score additional points. There are 2 types of SCORING ELEMENTS used in REEFSCAPE: CORAL and ALGAE.

5.7.1 CORAL

Figure 5-19 CORAL



A CORAL is a 11 $\frac{7}{8}$ in. long (~30 cm) piece of 4 in. diameter Schedule 40 Cellular (Foam) Core PVC pipe. CORAL has a 4-in. (~102 mm) inside diameter and a 4 $\frac{1}{2}$ -in. (~11 cm) outside diameter. CORAL is available for purchase from AndyMark, [am-5601](#) or can be cut from longer lengths of 4 in. diameter Schedule 40 Cellular (Foam) Core PVC pipe.

Prior to kickoff, CORAL was known as “Game Piece 1” and not available for pre-order prior to the season.

CORAL in the KOP and at events has a weight of between 1.1-1.8 lbs. (~0.5-0.8 kg) and has text marking along the length of the pipe that may vary in color.

Teams should be aware that CORAL and PVC pipe from different sources may have variances in color, markings, and weight.

CORAL undergoes wear and tear during a competition. Generally, a CORAL that still appears to look approximately like a CORAL is considered a CORAL for the purposes of rule evaluation and scoring, whether damaged or not. Small chunks of a CORAL are not considered a CORAL.

The edge of the CORAL may be rough or sharp. Teams should use caution when handling CORAL.

5.7.2 ALGAE

Figure 5-20: ALGAE

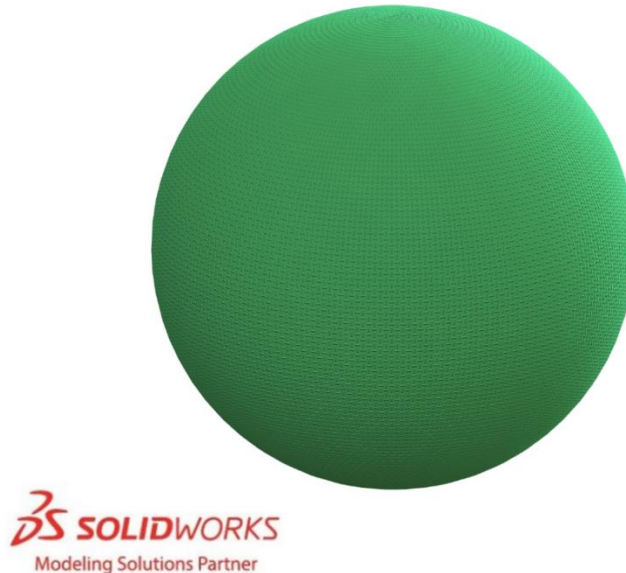

Each ALGAE is a 16 in. (41 cm) $\pm \frac{1}{2}$ in. (~ 12 mm) diameter rubber playground ball. The ball is custom made for FIRST by Baden Sports and sold by AndyMark [am-5602](#).

Prior to kickoff, ALGAE was known as “Game Piece 2” and was available for pre-order prior to the season.

At events, ALGAE will be inflated using a sizing gauge so that the diameter measures between 15.5 in. (~ 39 cm) and 16.5 in. (~ 42 cm)

The tolerances to which ALGAE are manufactured allow for variances in diameter, wall thickness, weight distribution and overall weight. They may not always be uniformly spherical, roll straight, or bounce as expected.

5.8 AprilTags

AprilTags are $8\frac{1}{8}$ in. (~ 21 cm) square targets located above CAGES, PROCESSORS, CORAL STATIONS and on REEFS. There are 22 unique markers on the FIELD, positioned as shown in [Figure 5-21](#).

Figure 5-21 AprilTag locations

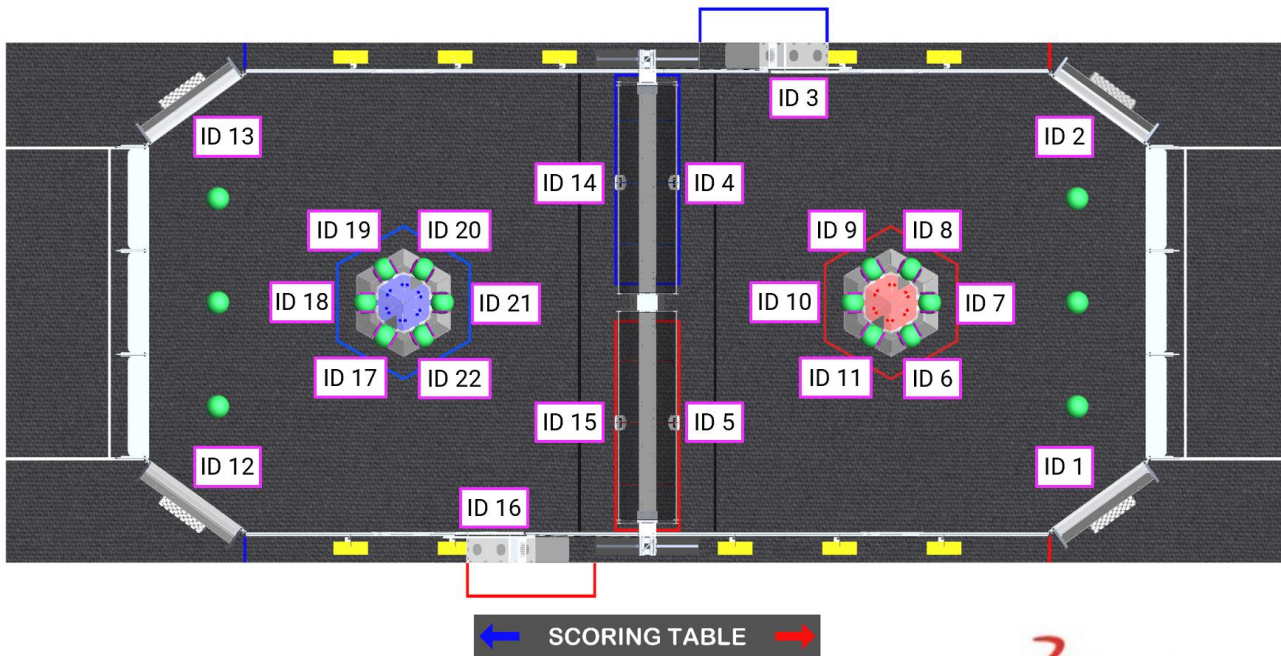

All markers are from the 36h11 tag family, IDs 1-22. All AprilTags are mounted to and centered on a 10½ in. (~27 cm) square polycarbonate panel. Each marker has an identifying text label. If AprilTags experience wear and marking during MATCHES, they are repaired with gaffers tape.

Figure 5-22 AprilTag sizing

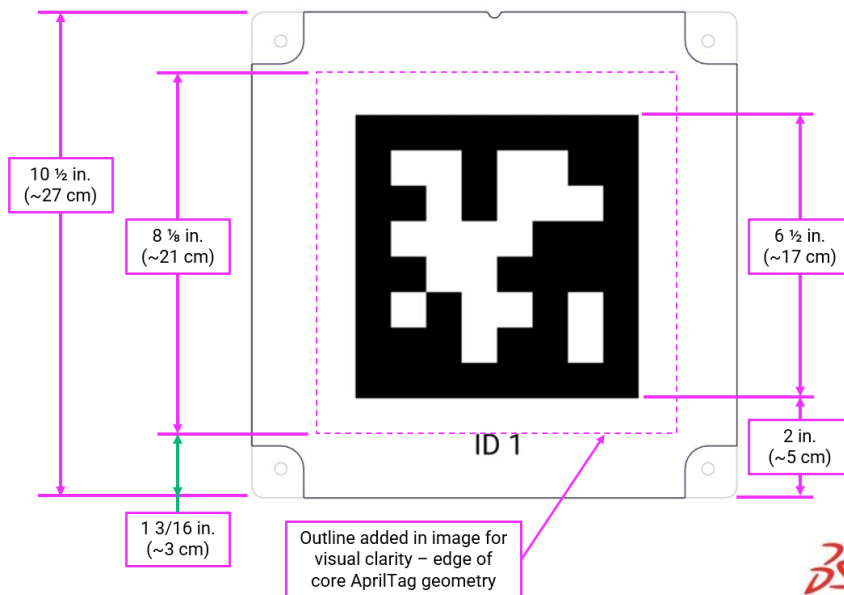

CORAL STATION AprilTags (IDs 1, 2, 12, and 13) are mounted to the CORAL STATION. The bottom of each tag's panel is 4 ft. 5¼ in. (~135 cm) above the carpet and centered on the CORAL STATION.

Figure 5-23: CORAL STATION AprilTags

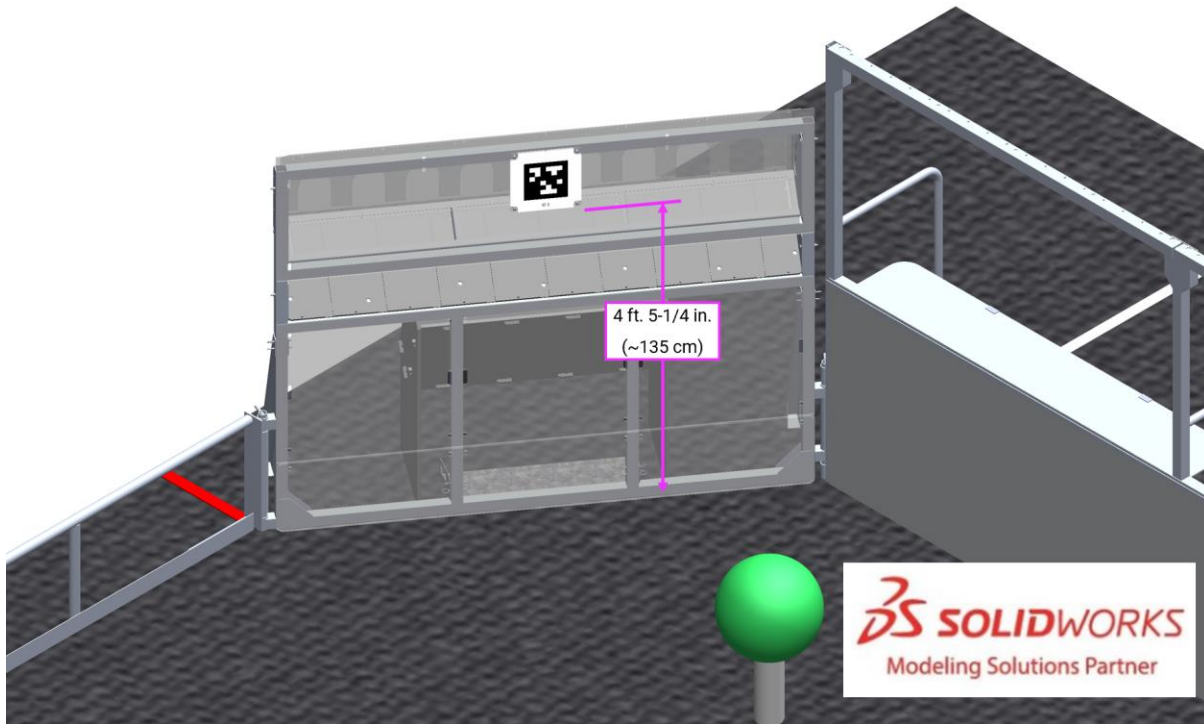

PROCESSOR AprilTag panels (IDs 3 and 16) are 3 ft. 9⅞ in. (~117 cm) above the carpet and centered horizontally above the opening in the PROCESSOR WALL.

Figure 5-24: PROCESSOR AprilTags

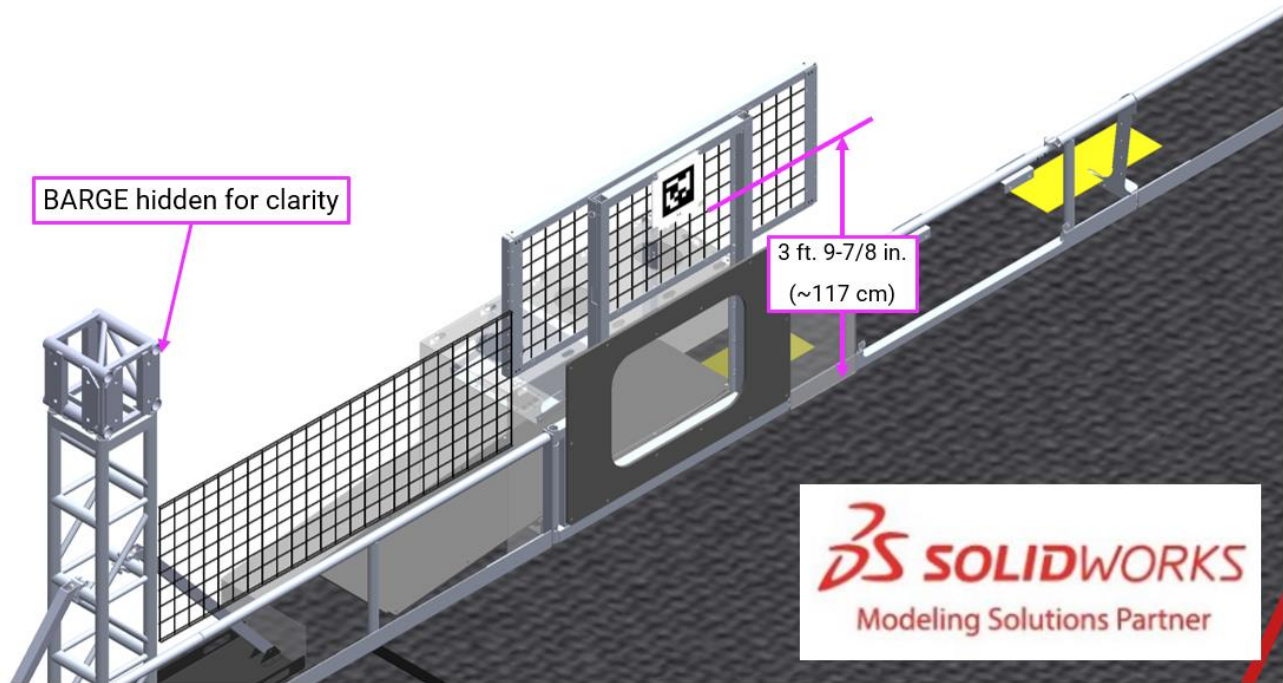

REEF AprilTag plates (IDs 6-11 and 17-22) are $6\frac{7}{8}$ in. (~17 cm) above the carpet and centered horizontally on each of the faces REEF.

Figure 5-25: REEF AprilTags

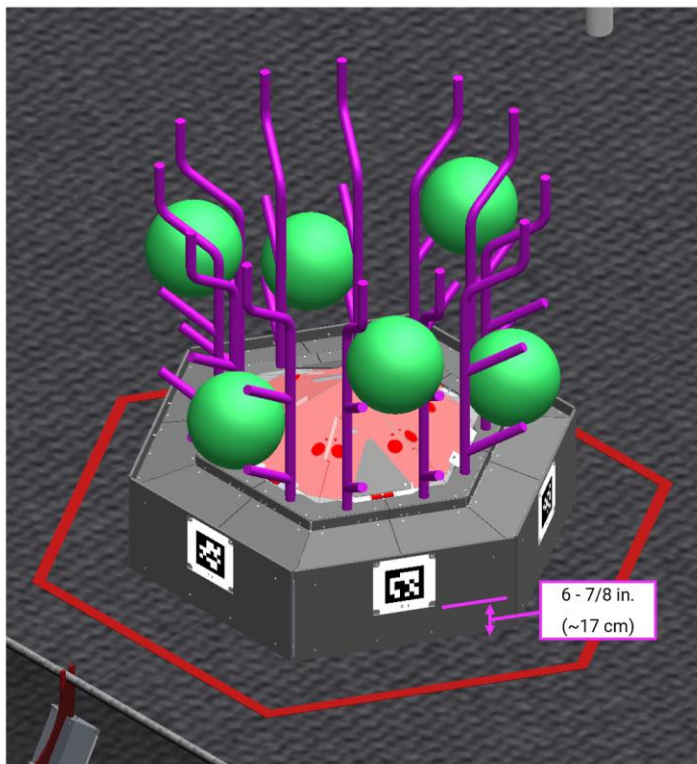

BARGE AprilTag plates (IDs 4, 5, 14, 15) are 5 ft. 9 in. (~178 cm) above the carpet, approximately centered above the middle CAGE, and angled 30° from vertical.

Figure 5-26: BARGE AprilTags

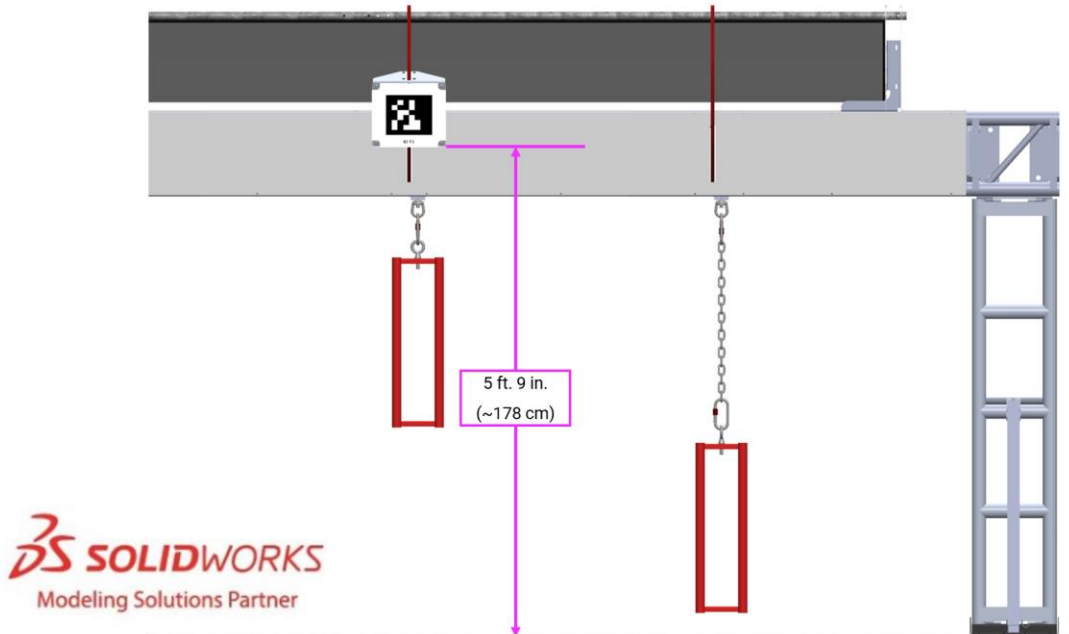

For further marker locating information please refer to the [2025 ARENA Layout and Marking Diagram](#). Printable versions of the markers are available on the [2025 Playing FIELD webpage](#).

5.9 The FIELD Management System

The FIELD Management System (FMS) is all the electronics responsible for sensing and controlling the FIRST Robotics Competition FIELD. The FMS encompasses all FIELD electronics, including computers, REFEREE touchscreens, the wireless access point, sensors, stack lights, A-Stops and E-Stops, etc.

When a DRIVE TEAM connects the Ethernet cable from their assigned DRIVER STATION to their OPERATOR CONSOLE, the Driver Station Software on the OPERATOR CONSOLE computer communicates with FMS. Once connected, the open ports available are described in [Table 8-5](#).

Note that ROBOT code cannot be deployed while connected to the FMS. Additional information about the FMS may be found in the [FMS Whitepaper](#).

The FMS alerts participants to milestones in the MATCH using audio cues detailed in [Table 5-1](#). Please note that audio cues are intended as a courtesy to participants and not intended as official MATCH markers. If there is a discrepancy between an audio cue and the FIELD timers, the FIELD timers are the authority.

Table 5-1 Audio cues

Event	Timer Value	Audio Cue
MATCH start	0:15 (for AUTO)	“Cavalry Charge”
AUTO ends	0:00 (for AUTO)	“Buzzer”
TELEOP begins	2:15	“3 Bells”

Event	Timer Value	Audio Cue
Final 20 seconds	0:20	“Submarine Sonar Ping”
MATCH end	0:00	“Buzzer”
MATCH stopped	n/a	“Foghorn”

5.10 FIELD STAFF

FIELD STAFF are responsible for making sure the MATCHES are cycled through efficiently, fairly, safely, and with a spirit of cooperation, Gracious Professionalism, and generosity of spirit. FIELD STAFF roles are filled by volunteers from the community who prepare for the event with thorough training and certification. There are 3 FIELD-side key volunteer roles with whom teams should be familiar and are encouraged to use as resources to make their event experience valuable (in whatever way the team defines “valuable”).

- Head REFEREE – trains, directs, and supervises REFEREES. They oversee all scoring processes and procedures in collaboration with the *FIRST* Technical Advisor (FTA). They interact with STUDENTS, volunteers, and contracted/*FIRST* staff. The Head REFEREE is positioned between the FIELD and the scoring table and wears a yellow shirt. The Head REFEREE has final authority for decisions regarding MATCH scores, penalties, and YELLOW and RED CARD assignments. For additional details, please refer to the [Head REFEREE role description](#).
- *FIRST* Technical Advisor (FTA) - ensures events run smoothly, safely, and in accordance with *FIRST* requirements. The FTA collaborates with *FIRST* staff, event staff, and other event volunteers in many different areas at events. The FTA is the liaison between *FIRST* HQ and the event for all things related to the FIELD, ROBOTS, and game, acts as a team advocate for all teams competing at the event and is a major point of escalation and conflict resolution for the event. For additional details, please refer to the [FTA role description](#).
- FIELD Supervisor - directs activity on the FIELD to ensure efficient execution of the MATCHES, pacing of the event, and smooth flow of MATCH play. FIELD Supervisors are responsible for ensuring the FIELD is intact and lead FIELD Reset teams, who are responsible for resetting the FIELD after each MATCH in preparation for the subsequent MATCH. For additional details, please refer to the [FIELD Supervisor role description](#).



6 Game Details

Figure 6-1 REEFSCAPE

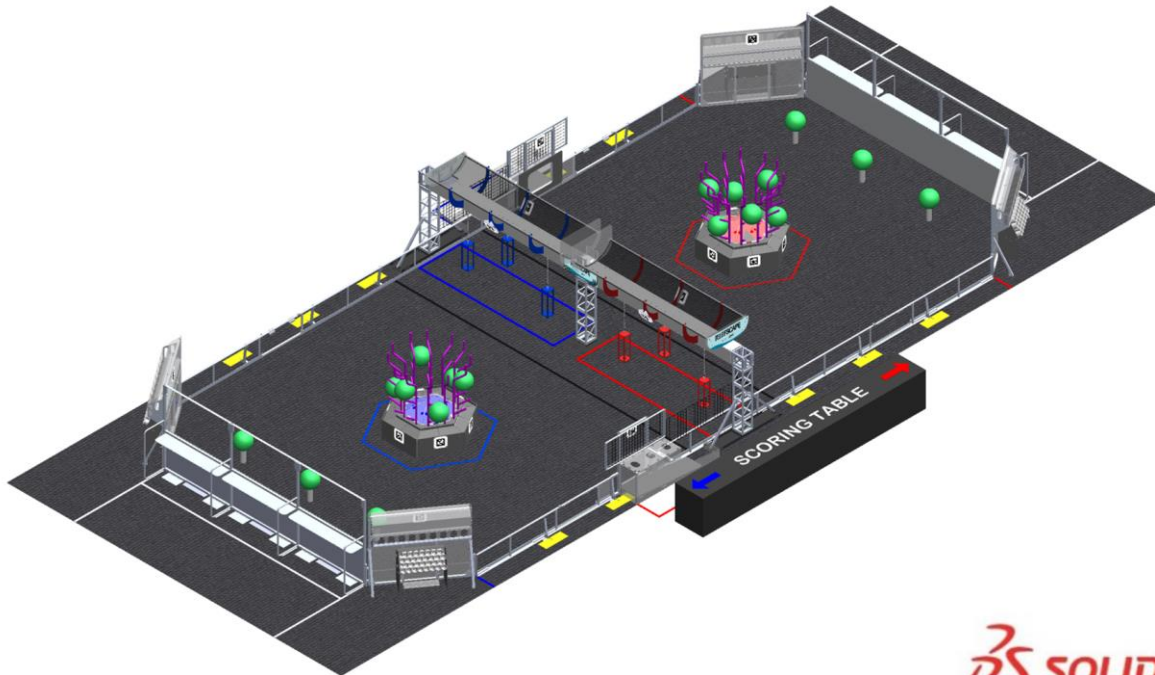

In REEFSCAPE, 2 ALLIANCES (an ALLIANCE is a cooperative of up to 4 FIRST Robotics Competition teams) play MATCHES, set up and implemented per the details described below.

6.1 MATCH Overview

MATCHES run on 7–10-minute cycles, which consist of pre-MATCH setup, the 2-minute and 30-second MATCH, and the post-MATCH reset.

During the MATCH, ROBOTS collect CORAL and score on their REEF. ROBOTS also collect ALGAE and score in their PROCESSOR or NET. HUMAN PLAYERS can score ALGAE in their NET once it has been passed to them via their opponent's PROCESSOR.

ROBOTS conclude the MATCH PARKING in their BARGE ZONE or suspending from a CAGE.

6.2 DRIVE TEAM

A DRIVE TEAM is a set of up to 5 people from the same FIRST Robotics Competition team responsible for team performance for a specific MATCH. There are 4 specific roles on a DRIVE TEAM which ALLIANCES can use to assist ROBOTS with REEFSCAPE, and no more than 1 member of the DRIVE TEAM may be a non-STUDENT.

The intent of the definition of DRIVE TEAM and DRIVE TEAM related rules is that, barring extenuating circumstances, the DRIVE TEAM consists of people who arrived at the event affiliated with that team and are responsible for their team's and ROBOT'S performance at the event (this means a person may be affiliated

with more than 1 team). The intent is not to allow teams to “adopt” members of other teams for strategic advantage for the loaning team, borrowing team, and/or their ALLIANCE (e.g. an ALLIANCE CAPTAIN believes 1 of their DRIVERS has more experience than a DRIVER on their first pick, and the teams agree the first pick team will “adopt” that DRIVER and make them a member of their DRIVE TEAM for Playoffs).

The definition isn’t stricter for 2 main reasons. First, to avoid additional bureaucratic burden on teams and event volunteers (e.g. requiring that teams submit official rosters that Queuing must check before allowing a DRIVE TEAM into the ARENA). Second, to provide space for exceptional circumstances that give teams the opportunity to display *Gracious Professionalism* (e.g. a bus is delayed, a COACH has no DRIVERS, and their pit neighbors agree to help by loaning DRIVERS as temporary members of the team until their bus arrives).

Table 6-1 DRIVE TEAM roles

Role	Description	Max./ DRIVE TEAM	Criteria
COACH	a guide or advisor	1	any team member, must wear “COACH” button
TECHNICIAN	a resource for ROBOT troubleshooting, setup, and removal from the FIELD	1	any team member, must wear “TECHNICIAN” button
DRIVER	an operator and controller of the ROBOT	3	STUDENT, must wear a “DRIVE TEAM” button
HUMAN PLAYER	a SCORING ELEMENT manager		

A STUDENT is a person who has not completed high-school, secondary school, or the comparable level as of September 1 prior to Kickoff.

The TECHNICIAN provides teams with a technical resource for pre-MATCH setup, ROBOT connectivity, OPERATOR CONSOLE troubleshooting, and post-MATCH removal of the ROBOT. Some pre-MATCH responsibilities for the TECHNICIAN may include, but are not limited to:

- location of the ROBOT radio, its power connection, and understanding of its indicator lights
- location of the roboRIO and understanding of its indicator lights
- username and password for the OPERATOR CONSOLE
- restarting the Driver Station and Dashboard software on the OPERATOR CONSOLE
- changing the bandwidth utilization (e.g. camera resolution, frame rate, etc.)
- changing a battery
- charging pneumatics

While the TECHNICIAN may be the primary technical member of the DRIVE TEAM, all members of the DRIVE TEAM are encouraged to have knowledge of the basic functionality of the ROBOT, such as the location and operation of the main

circuit breaker, connecting and resetting joysticks or gamepads from the OPERATOR CONSOLE, and removing the ROBOT from the FIELD.

6.3 Setup

Before each MATCH begins, FIELD STAFF stage SCORING ELEMENTS as described in section [6.3.4 SCORING ELEMENTS](#). DRIVE TEAMS stage their ROBOTS (as described in section [6.3.3 ROBOTS](#)) and OPERATOR CONSOLES (as described in section [6.3.2 OPERATOR CONSOLES](#)). Then, DRIVE TEAMS take their places as described in section [6.3.1 DRIVE TEAMS](#).

6.3.1 DRIVE TEAMS

DRIVE TEAMS prepare for a MATCH by staging in the appropriate areas, according to their role on the DRIVE TEAM, and by identifying themselves accordingly. DRIVE TEAM starting conditions are listed below, and a DRIVE TEAM obstructing or delaying any of the conditions is at risk of violating [G301](#).

- A. only DRIVE TEAM members assigned to the upcoming MATCH are present,
- B. only DRIVE TEAM members whose ROBOTS have passed initial, complete Inspection are present,
- C. no more than 1 HUMAN PLAYER is staged in their PROCESSOR AREA,
- D. any number of HUMAN PLAYERS are staged in their CORAL STATION AREAS,
- E. HUMAN PLAYERS not included in C or D, DRIVERS, and COACHES are in their ALLIANCE AREA and behind the HUMAN STARTING LINE,
- F. TECHNICIANS are in the event-designated area near the FIELD,
- G. DRIVE TEAM members clearly display their designated buttons above their waists (COACH - “Coach”, DRIVERS and HUMAN PLAYERS - “Drive Team”, and TECHNICIAN - “Technician”), and
- H. if a Playoff MATCH, the ALLIANCE CAPTAIN clearly displays their designated ALLIANCE CAPTAIN identifier (e.g. hat or armband).

6.3.2 OPERATOR CONSOLES

DRIVE TEAMS set up their OPERATOR CONSOLE as soon as the DRIVE TEAM from the previous MATCH has cleared the area. OPERATOR CONSOLES must be compliant with all relevant rules, specifically those in section [8.9 OPERATOR CONSOLE](#). The OPERATOR CONSOLE is plugged into the team’s assigned DRIVER STATION, as indicated on the team sign. Any control devices worn or held by their HUMAN PLAYERS and/or DRIVERS during the MATCH must be disconnected from or set on or beside the OPERATOR CONSOLE before the MATCH can begin. A DRIVE TEAM obstructing or delaying OPERATOR CONSOLE setup is at risk of violating [G301](#).

For the purposes of FIRST Robotics Competition, any device connected to the OPERATOR CONSOLE is considered a control device because REFEREES are not expected to differentiate between devices that can or cannot control the ROBOT.

6.3.3 ROBOTS

DRIVE TEAMS stage their ROBOT in accordance with [G303](#). A DRIVE TEAM obstructing or delaying ROBOT setup requirements is at risk of violating [G301](#).

If order of placement matters to either or both ALLIANCES, the ALLIANCE notifies the Head REFEREE during setup for that MATCH, and the Head REFEREE instructs ALLIANCES to alternate placement of ROBOTS. In a Qualification MATCH, REFEREE instructions are that ROBOTS are placed in the following order:

1. red DRIVER STATION 1 ROBOT
2. blue DRIVER STATION 1 ROBOT
3. red DRIVER STATION 2 ROBOT
4. blue DRIVER STATION 2 ROBOT

5. red DRIVER STATION 3 ROBOT
6. blue DRIVER STATION 3 ROBOT

In an intra-Division Playoff MATCH, the same pattern is applied, but instead of blue ALLIANCE placing last, the higher seeded ALLIANCE (regardless of color) places last. For inter-Division Playoff MATCHES, the ALLIANCE that places last is determined by a (real or virtual) coin flip facilitated by the Head REFEREE where a “heads” result invites the red ALLIANCE to place last.

FIELD STAFF may ask teams to indicate their intended location and are not required to wait for a team to stage their ROBOT in its exact location before moving to the next team.

6.3.4 SCORING ELEMENTS

Before each MATCH begins, FIELD STAFF stage SCORING ELEMENTS.

Figure 6-2 CORAL MARK locations and SCORING ELEMENT staging positions

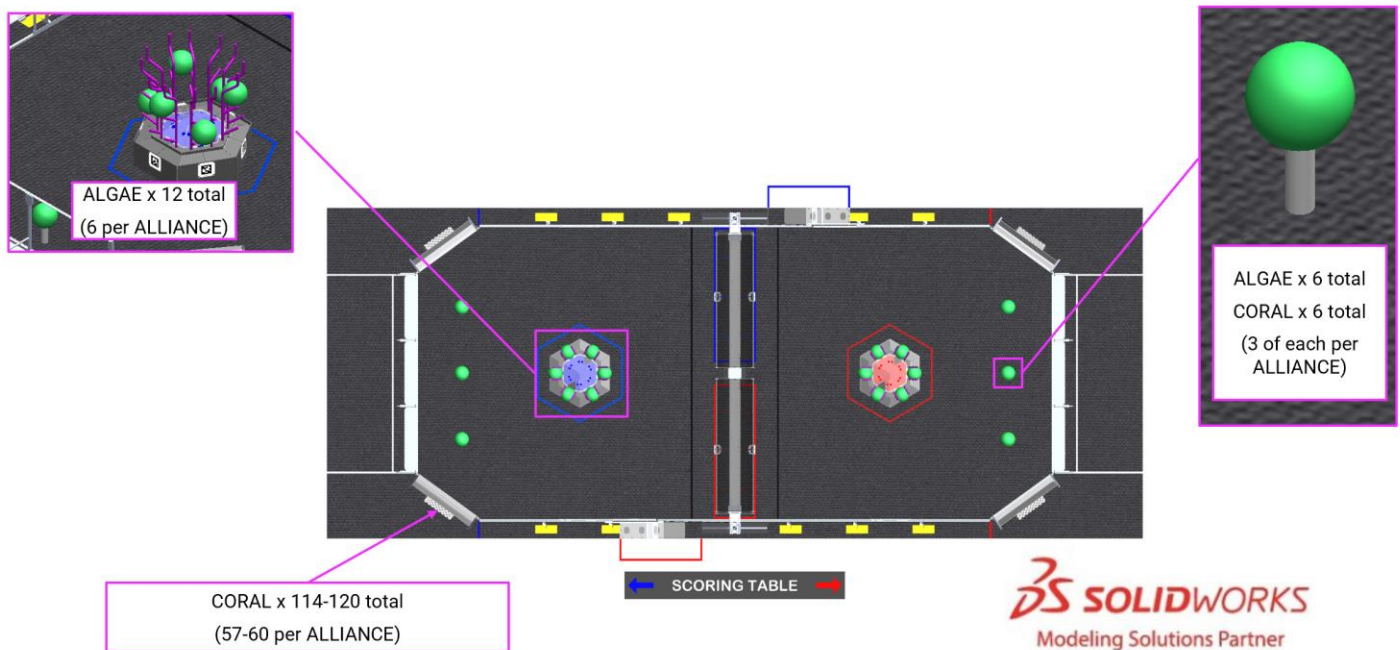

6.3.4.1 CORAL

126 CORAL are staged for each MATCH as follows (reference [Figure 6-2](#)):

- A. 1 CORAL is staged on each CORAL MARK (6 total, CORAL are staged such that each CORAL covers the opposite ends of each CORAL MARK),
- B. 1 CORAL may be preloaded in each ROBOT by the ROBOT’S DRIVE TEAM, such that the CORAL is fully supported by the ROBOT (up to 6 total, a CORAL not pre-loaded in a ROBOT is staged with CORAL in the corresponding ALLIANCE AREA), and
- C. remaining CORAL are split evenly behind each CORAL STATION (57 to 60 per ALLIANCE, depending on how many are preloaded in ROBOTS).

6.3.4.2 ALGAE

18 ALGAE are staged for each MATCH as follows (reference [Figure 6-2](#)):

- A. 6 ALGAE are staged on pairs of BRANCHES as shown in [Figure 6-3](#) (12 total), and
- B. 1 ALGAE is placed on top of each CORAL staged on a CORAL MARK (6 total).

Figure 6-3 Staging positions for ALGAE on a REEF

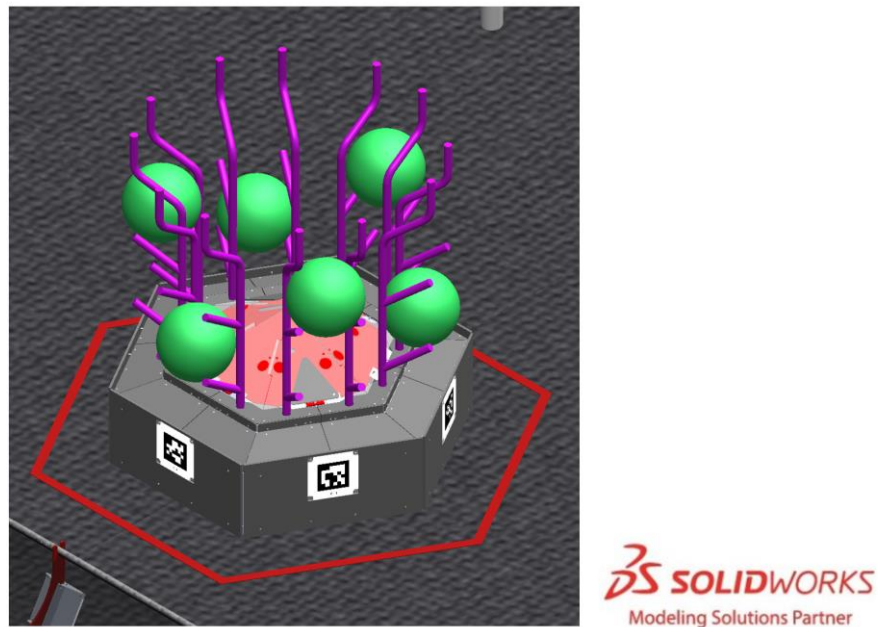

6.3.5 CAGES

Each team can choose the height of the CAGE closest to their driver station. By default, all CAGES are left in the state from the last match. At the start of each day, all CAGES are set as deep CAGES. If a team would like to alter the CAGE height they must alert the FIELD STAFF during reset. Each team informs FIELD STAFF of their preference for their corresponding CAGE height.

Figure 6-4 CAGE positions corresponding to DRIVER STATIONS

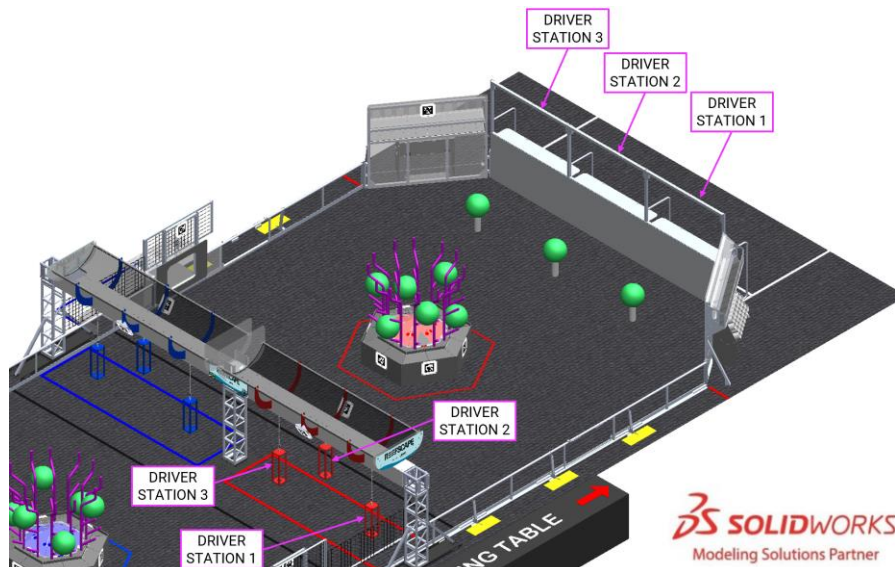

6.4 MATCH Phases

The first phase of each MATCH is 15 seconds long and called the Autonomous Period (AUTO). During AUTO, ROBOTS operate without any DRIVE TEAM control or input. ROBOTS attempt to leave their ROBOT STARTING LINE, score SCORING ELEMENTS, and retrieve SCORING ELEMENTS. There is a 3-second delay between AUTO and TELEOP for scoring purposes as described in section [6.5 Scoring](#).

The second phase of each MATCH is the remaining 2 minutes and 15 seconds (2:15) and called the Teleoperated Period (TELEOP). During TELEOP, DRIVERS remotely operate ROBOTS to retrieve and score SCORING ELEMENTS and climb their CAGES.

6.5 Scoring

ALLIANCES are rewarded for accomplishing various actions throughout a MATCH, including LEAVING their ROBOT STARTING LINE, scoring CORAL on their REEF, scoring ALGAE in their PROCESSOR and NET, climbing CAGES, and winning or tying MATCHES.

Rewards are granted either via MATCH points, *Coopertition* points, or Ranking Points (often abbreviated to RP, which increase the measure used to rank teams in the Qualification Tournament).

All scores are assessed and updated throughout the MATCH, except as follows:

- A. assessment of CORAL scored on the REEF and ALGAE scored in the PROCESSOR or NET continues for up to 3 seconds after the ARENA timer displays 0:00 following AUTO.
- B. assessment of CORAL scored on the REEF and ALGAE scored in the PROCESSOR or NET continues for up to 3 seconds after the ARENA timer displays 0:00 following TELEOP.
- C. assessment of CAGE points is made 3 seconds after the ARENA timer displays 0:00 following TELEOP, or when all ROBOTS have come to rest following the conclusion of the MATCH, whichever happens first.

LEAVING the ROBOT STARTING LINE, CORAL scoring, ALGAE scoring in the NET, PARKING and CAGE points are all evaluated and scored by human volunteers. Teams are encouraged to make sure that it is obvious and unambiguous that the criteria are met.

6.5.1 SCORING ELEMENT Scoring Criteria

A CORAL is scored in the trough (L1) of the REEF if it is not in contact with a ROBOT and

- A. contacting the trough, or
- B. fully or partially supported by a CORAL in contact with the trough.

Figure 6-5 Examples of CORAL scored in the trough (L1)

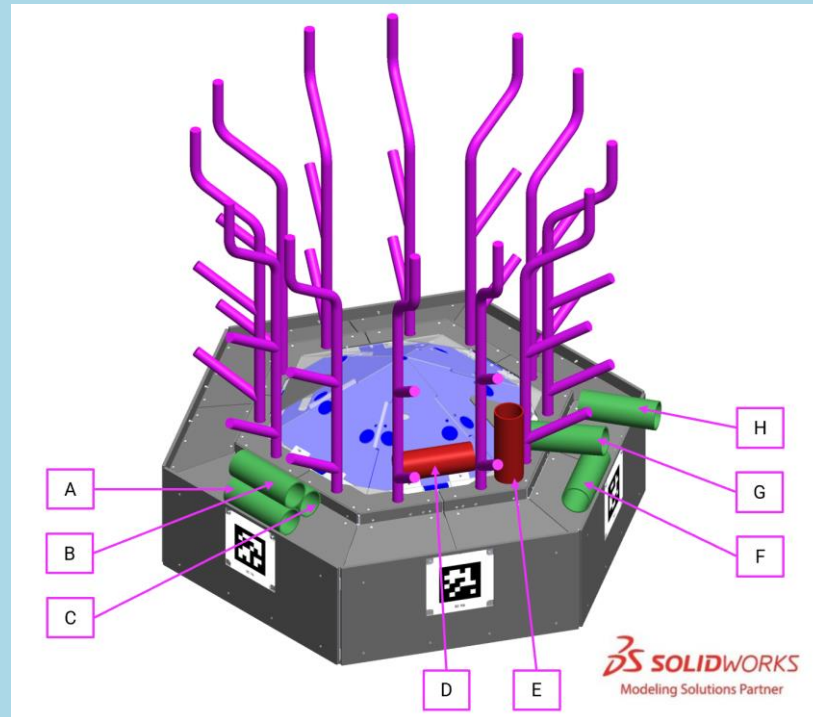

Figure 6-5 includes examples of CORAL on the REEF at the conclusion of a MATCH.

- A. CORAL A, C, F, and H are scored because they meet criteria A.
- B. CORAL B and G are scored because they meet criteria B.
- C. CORAL D and E do not meet any criteria for trough scoring.

A CORAL is scored on L2-L4 BRANCH if the end of the BRANCH is inside the volume of the CORAL and the CORAL is not in contact with a ROBOT or an ALGAE.

An ALGAE is scored in a PROCESSOR once it has passed through the opening of the PROCESSOR and by the sensor array. An ALGAE is scored in a NET if it is above the NET and within the perimeter of the NET.

If a CORAL scored in AUTO gets removed from a BRANCH during TELEOP, the AUTO points are removed. If a CORAL is scored in that location again, the AUTO points associated with the original scored CORAL is restored. CORAL scored in the trough is not tracked by specific location, if a CORAL is removed from the trough after AUTO, the points removed will correspond to the lowest scoring CORAL (i.e. TELEOP CORAL removed first); if CORAL is re-scored in the trough, points will be re-added in the reverse order (i.e. AUTO CORAL re-added first).

6.5.2 ROBOT Scoring Criteria

To qualify for LEAVE points, a ROBOT must move such that its BUMPERS no longer overlap its ROBOT STARTING LINE at the end of AUTO.

To qualify for PARK points, a ROBOT'S BUMPERS must be partially or completely contained in their BARGE ZONE at the end of the MATCH and does not meet the criteria for CAGE points.

To qualify for CAGE points, a ROBOT must be contacting a CAGE (with the exception of the ANCHOR), not contacting the carpet, and may additionally contact only the following elements:

- A. SCORING ELEMENTS,

- B. another ROBOT qualified for CAGE points,
- C. a partner ROBOT contacted by an opponent in violation of [G428](#), and
- D. an opponent ROBOT.

6.5.3 Coopertition Bonus

In Qualification MATCHES, if both ALLIANCES score at least 2 ALGAE in their PROCESSOR, all teams earn 1 *Coopertition* Point, and the threshold for the CORAL RP decreases as described in [Table 6-2](#).

See section [10.5.3 Qualification Ranking](#) for more information about *Coopertition* influence on Qualification Ranking order.

6.5.4 Point Values

Point values for tasks in REEFSCAPE are detailed in [Table 6-2](#).

Table 6-2 REEFSCAPE point values

		MATCH points		Ranking Points	Coopertition Points
		AUTO	TELEOP		
LEAVE		3			
CORAL	CORAL scored in trough (L1)	3	2		
	CORAL scored on L2 BRANCH	4	3		
	CORAL scored on L3 BRANCH	6	4		
	CORAL scored on L4 BRANCH	7	5		
ALGAE	scored in PROCESSOR	6	6		
	scored in NET	4	4		
BARGE	PARK in the BARGE ZONE		2		
	off-the-ground via shallow CAGE		6		
	off-the-ground via deep CAGE		12		
Coopertition Bonus – at least 2 ALGAE scored in each PROCESSOR					1
AUTO RP - all enabled ROBOTS LEAVE and at least 1 CORAL scored in AUTO				1	
* CORAL RP - If at least 5 CORAL scored on each level. If <i>Coopertition</i> achieved, at least 5 CORAL scored on at least 3 levels.				1	
* BARGE RP - at least 14 BARGE points are scored				1	
Win	completing a MATCH with more MATCH points than your opponent			3	
Tie	completing a MATCH with the same number of MATCH points as your opponent			1	
*For District Championship and/or FIRST Championship events, the CORAL or BARGE RP requirement may increase.					

6.6 Violations

Upon any instance of a rule violation, unless otherwise noted, 1 or more of the penalties listed in [Table 6-3](#) are assessed. All rules throughout the Game Rules section are called as perceived by a REFEREE.

Table 6-3 Rule violations

Penalty	Description
MINOR FOUL	a credit of 2 points towards the opponent's MATCH point total
MAJOR FOUL	a credit of 6 points towards the opponent's MATCH point total
YELLOW CARD	issued by the Head REFEREE for egregious ROBOT or team member behavior or rule violations. A subsequent YELLOW CARD within the same tournament phase results in a RED CARD.
RED CARD	issued by the Head REFEREE for egregious ROBOT or team member behavior or rule violations which results in a team being DISQUALIFIED for the MATCH.
DISABLED	the state in which a ROBOT is commanded to deactivate all outputs, rendering the ROBOT inoperable for the remainder of the MATCH.
DISQUALIFIED	the state of a team in which they receive 0 MATCH points and 0 Ranking Points in a Qualification MATCH or causes their ALLIANCE to receive 0 MATCH points in a Playoff MATCH
VERBAL WARNING	a warning issued by event staff or the Head REFEREE.

6.6.1 YELLOW and RED CARDS

In addition to rule violations explicitly listed throughout this document, YELLOW CARDS and RED CARDS are used in FIRST Robotics Competition to address team and ROBOT behavior that does not align with the mission, values, and culture of FIRST.

The Head REFEREE may assign a YELLOW CARD as a warning, or a RED CARD for egregious behavior inappropriate at a FIRST Robotics Competition event.

A YELLOW or RED CARD is indicated by the Head REFEREE holding a YELLOW and/or RED CARD in the air while the Game Announcer describes the violation.

YELLOW CARDS are additive, meaning that a second YELLOW CARD is automatically converted to a RED CARD. A team is issued a RED CARD for any subsequent incident in which they receive an additional YELLOW CARD, including earning a second YELLOW CARD during a single MATCH. A second YELLOW CARD is indicated by the Head REFEREE holding a YELLOW CARD and RED CARD in the air simultaneously after the completion of the MATCH. A team that has received either a YELLOW CARD or a RED CARD carries a YELLOW CARD into subsequent MATCHES, except as noted below.

Once a team receives a YELLOW or RED CARD, a yellow rectangle will show next to the team number on the audience display during subsequent MATCHES, including any replays.

Figure 6-6 Example audience screen graphic showing YELLOW CARD indicators



All YELLOW CARDS are cleared in FMS at the conclusion of Practice, Qualification, and division Playoff MATCHES. VERBAL WARNINGS issued by the head REFEREE are cleared after Practice MATCHES and persist from Qualification MATCHES through subsequent tournament phases.

6.6.2 YELLOW and RED CARD application

YELLOW and RED CARDS are applied based on the following:

Table 6-4 YELLOW and RED CARD application

Time YELLOW or RED CARDS earned:	MATCH to which CARD is applied:
Prior to Qualification MATCHES	REFEREES may or may not be present during Practice MATCHES. With input from event staff, The Head REFEREE may opt to perpetuate a VERBAL WARNING or YELLOW CARD earned prior to Qualification MATCHES to the first Qualification MATCH for particularly egregious behavior.
during the Qualification MATCHES	team's current (or just-completed) MATCH. In the case where the team participated as a SURROGATE in the current (or just completed) MATCH, the card is applied to the team's previous MATCH (i.e. the team's second Qualification MATCH)
between the end of Qualification MATCHES and the start of Playoff MATCHES	ALLIANCE'S first Playoff MATCH
during the Playoff MATCHES	ALLIANCE'S current (or just-completed) MATCH

Please see examples of the application of YELLOW and RED CARDS as shown in section [6.6.4 Violation Details](#).

6.6.3 YELLOW and RED CARDS during Playoff MATCHES

During Playoff MATCHES, YELLOW and RED CARDS are assigned to the violating team's entire ALLIANCE instead of to only the violating team. If an ALLIANCE receives 2 YELLOW CARDS, the entire ALLIANCE is issued a RED CARD which results in DISQUALIFICATION for the associated MATCH. If both ALLIANCES receive a RED CARD, the ALLIANCE assessed the first RED CARD, chronologically, is DISQUALIFIED and loses the MATCH.

6.6.4 Violation Details

There are several styles of violation wording used in this manual. Below are some example violations and a clarification of the way the violation would be assessed. The examples shown do not represent all possible violations, but rather a representative set of combinations.

Table 6-5 Violation examples

Example Violation	Expanded Interpretation
MINOR FOUL	Upon violation, a MINOR FOUL is assessed against the violating ALLIANCE.

Example Violation	Expanded Interpretation
MAJOR FOUL and YELLOW CARD	Upon violation, a MAJOR FOUL is assessed against the violating ALLIANCE. After the MATCH, the Head REFEREE presents the violating team with a YELLOW CARD.
MINOR FOUL per additional SCORING ELEMENT. If egregious, YELLOW CARD	Upon violation, a number of MINOR FOULS are assessed against the violating ALLIANCE equal to the number of additional SCORING ELEMENTS beyond the permitted quantity. Additionally, if the REFEREES determine that the action was egregious, the Head REFEREE presents the violating team with a YELLOW CARD after the MATCH.
MINOR FOUL. MAJOR FOUL IF REPEATED	Upon initial violation in a MATCH, a MINOR FOUL is assessed against the violating ALLIANCE. If the ALLIANCE ROBOT repeats the infraction in the MATCH, a MAJOR FOUL is assessed against the violating ALLIANCE. Assuming no additional infractions of that rule by that ROBOT in that MATCH, the ROBOT has “earned” a MINOR FOUL and a MAJOR FOUL for their ALLIANCE.
MAJOR FOUL, and for every 3 seconds in which the situation is not corrected, a MAJOR FOUL is assessed	Upon violation, a MAJOR FOUL is assessed against the violating ALLIANCE and the REFEREE begins to count. Their count continues until the criteria to discontinue the count are met, and for each 3 seconds within that time, an additional MAJOR FOUL is assessed against the violating ALLIANCE. A ROBOT in violation of this type of rule for 15 seconds receives a total of 4 MAJOR FOULS (assuming no other rules were being simultaneously violated).
RED CARD for the ALLIANCE	After the MATCH, the Head REFEREE presents the violating ALLIANCE with a RED CARD in the following fashion: <ul style="list-style-type: none"> • In a PLAYOFF MATCH, a single RED CARD is assessed to the ALLIANCE. • In all other scenarios, each team on the ALLIANCE is issued a RED CARD.

6.7 Head REFEREE and FTA Interaction

The Head REFEREE has the ultimate authority in the ARENA during the event, but may receive input from additional sources, e.g. Game Designers, FIRST personnel, FTA, and other event staff. The Head REFEREE rulings are final. No event staff, including the Head REFEREE, will review video, photos, artistic renderings, etc. of any MATCH, from any source, under any circumstances.

6.7.1 Question Box (Q)

Each ALLIANCE has a designated Question Box near the scoring table. If a DRIVE TEAM has a question about a MATCH, the FIELD, etc., they may send 1 DRIVE TEAM member to their corresponding Question Box. Depending on timing, the Head REFEREE or FTA may postpone any requested discussion until the end of the subsequent MATCH.

Technical questions regarding FIELD or ROBOT operation are addressed by the FTA, and additional team members are invited to participate in these conversations if necessary. If a DRIVE TEAM needs clarification on a ruling or score, per [Q101](#), 1 STUDENT from that DRIVE TEAM should address the Head REFEREE after the ARENA Reset Signal (e.g. FIELD lights turn green).

While FMS tracks quantities of MINOR FOULS, FIRST instructs REFEREES to not self-track details about MINOR FOULS and MAJOR FOULS; as a result, REFEREES are not expected to recall details about what MINOR FOULS and MAJOR FOULS were made, when they occurred, and against whom.

Any reasonable question is fair game in the Question Box, and Head REFEREES will make good faith efforts to provide helpful feedback (e.g. how/why certain MINOR FOULS are being called, why a particular ROBOT may be susceptible to certain MINOR FOULS based on its design or game play, how specific rules are being called or interpreted), but please know that they may not be able to supply specific details.

Q101 *1 STUDENT, 1 Head REFEREE. A team may only address the Head REFEREE with 1 STUDENT. The STUDENT may not be accompanied by more than 1 silent observer.

Violation: The Head REFEREE will not address additional, non-compliant team members or peripheral conversations.

Some events may restrict ARENA access to members of the DRIVE TEAM. Team members are permitted to swap buttons within their team as needed to access the Question Box.

Laws regarding recording of conversations vary state-to-state and country-to-country, and, in some cases, recording without consent may be criminal. Introducing the idea of recording a conversation with an implied reason of proving someone's error can escalate a discussion and is likely to increase its adversarial nature. Sometimes it's appropriate; often it's neither appropriate nor constructive.

Please do not record FIRST event staff, or anyone at an event, without the person's consent and please do not challenge the decision to decline consent to be recorded. FIRST event staff are empowered to excuse themselves from an interaction in which they are being recorded after declining consent.

6.8 Other Logistics

SCORING ELEMENTS that leave the FIELD, other than ALGAE via the PROCESSOR, are placed back into the FIELD approximately at the point of exit by FIELD STAFF (REFEREES, FTAs, or other staff working around the FIELD) at the earliest safe opportunity.

Note that, except for ALGAE via the PROCESSOR, ROBOTS may not deliberately cause SCORING ELEMENTS to leave the FIELD (see [G407](#)).

An ARENA FAULT (an error in ARENA operation described in section [10.2 MATCH Replays](#)) is not called for MATCHES that accidentally begin with damaged SCORING ELEMENTS. Damaged SCORING ELEMENTS are not replaced until the next ARENA reset period. DRIVE TEAMS should alert the FIELD STAFF to any missing or damaged SCORING ELEMENTS prior to the start of the MATCH.

Once the MATCH is over and the Head REFEREE determines that the FIELD is safe for FIELD STAFF and DRIVE TEAMS, they or their designee change the FIELD lights to green and DRIVE TEAMS may retrieve their ROBOT.

During ARENA reset, the ARENA is cleared of ROBOTS and OPERATOR CONSOLES from the MATCH that just ended, ROBOTS and OPERATOR CONSOLES for the subsequent MATCH are loaded into the ARENA by DRIVE TEAMS, and FIELD STAFF reset ARENA elements.

FIRST Robotics Competition uses 3 words in the context of how durations and actions are assessed with regards to evaluation of rules and assignment of violations. These words provide general guidance to describe benchmarks to be used across the program. It is not the intent for REFEREES to provide a count during the time periods.

- MOMENTARY describes durations that are fewer than approximately 3 seconds.
- CONTINUOUS describes durations that are more than approximately 10 seconds.
- REPEATED describes actions that happen more than once within a MATCH.



7 Game Rules (G)

7.1 Personal Safety

- G101** ***Humans, stay off the FIELD until green.** A team member may only enter the FIELD if FIELD lighting (FIELD facing side of the team signs and timers) is green, unless explicitly instructed by a REFEREE or an FTA.

Violation: VERBAL WARNING. YELLOW CARD if subsequent violations during the event.

Violations of this rule apply to the entire team, not specifically to any 1 individual. For example, a member of Team 9999 enters the FIELD prior to lights going green after MATCH 3, and a different member enters the FIELD prior to lights going green after MATCH 25. The team receives a VERBAL WARNING for the first violation and a YELLOW CARD for the second.

- G102** ***Never step over the guardrail.** A team member may only enter or exit the FIELD through open gates.

Violation: VERBAL WARNING. YELLOW CARD if subsequent violations during the event.

Teams are encouraged to ensure that all members of their DRIVE TEAM are aware of this rule. It's easy to violate, particularly when teams are doing their best to move on and off the FIELD quickly. The violations of this rule are intended to avoid nuisance penalties, but still enforce safety requirements around the FIELD. There is the potential for injury when stepping over the guardrail.

Violations of this rule apply to the entire team, not specifically to any 1 individual. For example, a member of Team 9999 steps over the guardrail prior to MATCH 3, and a different member steps over the guardrail prior to MATCH 25. The team receives a VERBAL WARNING for the first violation and a YELLOW CARD for the second.

- G103** ***Be careful what you interact with.** A team member is prohibited from the following actions with regards to interaction with ARENA elements.
- climbing on or inside,
 - hanging from,
 - manipulating such that it doesn't return to its original shape without human intervention, and
 - damaging.

Violation: VERBAL WARNING. YELLOW CARD if subsequent violations during the event.

- G104** ***Teams may not enable their ROBOTS on the FIELD.** Teams may not tether to the ROBOT while on the FIELD except in special circumstances (e.g. after Opening Ceremonies, before an immediate MATCH replay, etc.) and with the express permission from the FTA or a REFEREE.

Violation: VERBAL WARNING. YELLOW CARD if subsequent violations during the event.

Teams are encouraged to consider this rule when developing their ROBOTS.

FMS will not enable ROBOTS after the conclusion of the MATCH.

For the purposes of this rule, tethering includes any wired or wireless connection used to electrically energize and/or control elements on the ROBOT. The safety of teams and volunteers in close proximity to ROBOTS and ARENA elements on

the FIELD is of the utmost importance, therefore ROBOTS or ROBOT COMPONENTS may not be enabled in any way on the FIELD before or after the MATCH.

ROBOTS need to be safely transported off the FIELD and back to the pits after the MATCH, and there may be bystanders, doorways, or height restrictions along the route.

7.2 Conduct

G201 *Be a good person. All teams must be civil toward everyone and respectful of team and event equipment while at a FIRST Robotics Competition event.

Violation: VERBAL WARNING. YELLOW CARD if subsequent violations during the event.

Examples of inappropriate behavior include, but are not limited to, the use of offensive language or other uncivil conduct.

Examples of particularly contemptible behavior that is likely to result in ARENA ejection include, but are not limited to, the following:

- A. assault, e.g. throwing something that hits another person (even if unintended),
- B. threat, e.g. saying something like “if you don’t reverse that call, I’ll make you regret it,”
- C. harassment, e.g. badgering someone with no new information after a decision’s been made or a question’s been answered,
- D. bullying, e.g. using body or verbal language to cause another person to feel inadequate,
- E. insulting, e.g. telling someone they don’t deserve to be on a DRIVE TEAM,
- F. swearing at another person (versus swearing under one’s breath or at oneself), and
- G. yelling at another person(s) in anger or frustration.

G202 *Don’t bang on the glass. A team member may never strike or hit the DRIVER STATION plastic windows.

Violation: VERBAL WARNING. YELLOW CARD if subsequent violations during the event.

G203 *Asking other teams to throw a MATCH – not cool. A team may not encourage an ALLIANCE of which it is not a member to play beneath its ability.

Note: This rule is not intended to prevent an ALLIANCE from planning and/or executing its own strategy in a specific MATCH in which all the teams are members of the ALLIANCE.

Violation: VERBAL WARNING. RED CARD if subsequent violations during the event.

Example 1: A MATCH is being played by Teams A, B, and C, in which Team C is encouraged by Team D to not get on a CAGE at the end of the MATCH, resulting in Teams A, B, and C not earning a Ranking Point. Team D’s motivation for this behavior is to prevent Team A from rising in the Tournament rankings and negatively affecting Team D’s ranking. Team D has violated this rule.

Example 2: A MATCH is being played by Teams A, B, and C, in which Team A is assigned to participate as a SURROGATE. Team D encourages Team A to not

participate in the MATCH so that Team D gains ranking position over Teams B and C. Team D has violated this rule.

Example 3: Asking a team to “no show” for a MATCH.

FIRST considers the action of a team influencing another team to throw a MATCH, to deliberately miss Ranking Points, etc. incompatible with *FIRST* values and not a strategy any team should employ.

G204 ***Letting someone coerce you into throwing a MATCH – also not cool.** A team, as the result of encouragement by a team not on their ALLIANCE, may not play beneath its ability.

Note: This rule is not intended to prevent an ALLIANCE from planning and/or executing its own strategy in a specific MATCH in which all the ALLIANCE members are participants.

Violation: VERBAL WARNING. RED CARD if subsequent violations during the event.

Example 1: A MATCH is being played by Teams A, B, and C. Team D requests Team C ignore the CAGES at the end of the MATCH, resulting in Teams A, B, and C not being able to earn the BARGE RP. Team C accepts this request from Team D. Team D’s motivation for this behavior is to prevent Team A from rising in the Tournament rankings negatively affecting Team D’s ranking. Team C has violated this rule.

Example 2: A MATCH is being played by Teams A, B, and C, in which Team A is assigned to participate as a SURROGATE. Team A accepts Team D’s request not to participate in the MATCH so that Team D gains ranking position over Teams B and C. Team A has violated this rule.

FIRST considers the action of a team influencing another team to throw a MATCH, to deliberately miss Ranking Points, etc. incompatible with *FIRST* values and not a strategy any team should employ.

G205 ***Throwing your own MATCH is bad.** A team may not intentionally lose a MATCH or sacrifice Ranking Points in an effort to lower their own ranking or manipulate the rankings of other teams.

Violation: VERBAL WARNING. RED CARD if subsequent violations during the event.

The intent of this rule is not to punish teams who are employing alternate strategies, but rather to ensure that it is clear that throwing MATCHES to negatively affect your own rankings, or to manipulate the rankings of other teams (i.e. throw a MATCH to lower a partner's ranking, and/or increase the ranking of another team not in the MATCH) is incompatible with *FIRST* values and not a strategy any team should employ.

G206 ***Don't violate rules for RPs.** A team or ALLIANCE may not collude with another team to each purposefully violate a rule in an attempt to influence Ranking Points.

Violation: YELLOW CARD and the ALLIANCE is ineligible for CORAL and BARGE RPs.

For example, if Team A on the blue ALLIANCE agrees with Team F on the red ALLIANCE to enter the blue BARGE ZONE during the last 20 seconds of a Qualification MATCH and wait to be contacted by Team F, and then both ROBOTS drive to the red BARGE ZONE so that Team A can contact Team F in their BARGE ZONE leading in both ALLIANCES being awarded the BARGE RP.

G207 *Don't abuse ARENA access. A team member (except DRIVERS, HUMAN PLAYERS, and COACHES) granted access to restricted areas in and around the ARENA (e.g. via TECHNICIAN button, event issued Media badges, etc.) may not assist or use signaling devices during the MATCH. Exceptions will be granted for inconsequential infractions and in cases concerning safety.

Violation: VERBAL WARNING. YELLOW CARD if subsequent violations during the event.

The TECHNICIAN'S role is to help the team prepare the ROBOT so it can perform at its full potential during a MATCH. The TECHNICIAN, except as described at the end of section [6.2 DRIVE TEAM](#), is not an additional COACH, DRIVER, or HUMAN PLAYER.

Team members in open-access spectator seating areas are not considered to be in a restricted area and are not prevented from assisting or using signaling devices. See [E102](#) for related details.

G208 *Show up to your MATCHES. If a ROBOT has passed initial, complete inspection, at least 1 member of its DRIVE TEAM must report to the ARENA and participate in each of their assigned Qualification and Playoff MATCHES.

Violation: DISQUALIFIED.

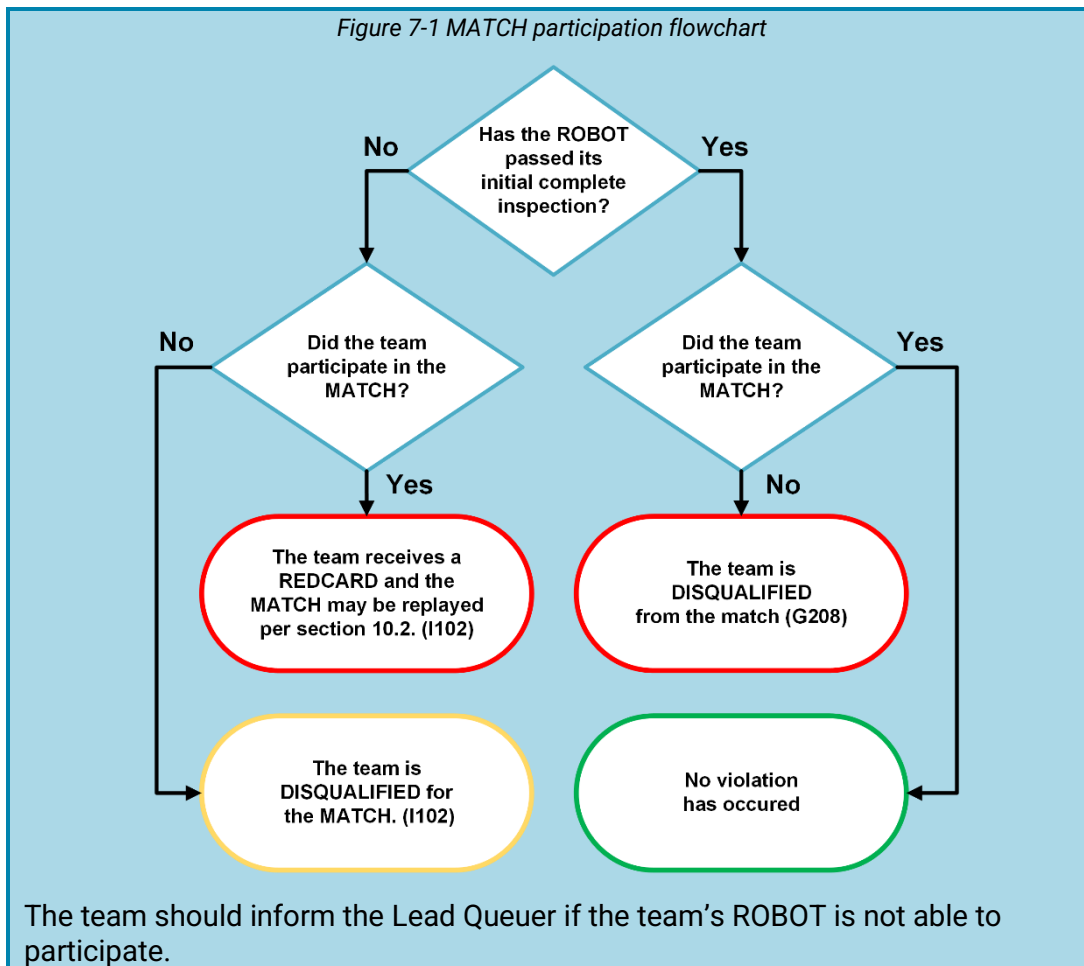

G209 *Keep your ROBOT together. A ROBOT may not intentionally detach or leave a part on the FIELD.

Violation: RED CARD.

- G210** ***Don't expect to gain by doing others harm.** A strategy not consistent with standard gameplay and clearly aimed at forcing the opponent ALLIANCE to violate a rule is not in the spirit of *FIRST* Robotics Competition and not allowed. Rule violations forced in this manner will not result in an assignment of a penalty to the targeted ALLIANCE.

Violation: MAJOR FOUL. YELLOW CARD if REPEATED.

This rule does not apply for strategies consistent with standard gameplay, for example:

- A. a red ALLIANCE ROBOT attempting to climb in their BARGE ZONE in the final 20 seconds of the MATCH contacts a blue ALLIANCE ROBOT.
- B. a blue ROBOT attempts to enter their REEF ZONE to score a CORAL and pushes a red ROBOT just outside the blue REEF ZONE into it.

This rule requires an intentional act with limited or no opportunity for the team being acted on to avoid the penalty such as:

- C. forcing an opponent ROBOT to have greater than MOMENTARY CONTROL of more than 1 of each SCORING ELEMENT.
- D. a blue ALLIANCE ROBOT, pushing a red ALLIANCE ROBOT from fully outside and far from (i.e. more than 4 ft. (~121 cm)) the blue BARGE ZONE through the blue BARGE ZONE while another red ROBOT is already on the opposing ALLIANCE's side of the FIELD and the REFEREE perceiving that the blue ROBOT is deliberately making the red ROBOT violate [G421](#).
- E. a blue ALLIANCE ROBOT, pushing a red ALLIANCE ROBOT from fully outside and far from (i.e. more than 4 ft. (~121 cm)) the blue BARGE ZONE into a CAGE and the REFEREE perceiving that the blue ROBOT is deliberately making the red ROBOT violate [G418](#).

- G211** ***Egregious or exceptional violations.** Egregious behavior beyond what is listed in the rules or subsequent violations of any rule or procedure during the event is prohibited.

In addition to rule violations explicitly listed in this manual and witnessed by a REFEREE, the Head REFEREE may assign a YELLOW or RED CARD for egregious ROBOT actions or team member behavior at any time during the event.

Please see section [6.6.1 YELLOW and RED CARDS](#) for additional detail.

Violation: YELLOW or RED CARD.

The intent of this rule is to provide the Head REFEREES the flexibility necessary to keep the event running smoothly, as well as keep the safety of all the participants as the highest priority. Behaviors that put the *FIRST* community or integrity of the game at risk are not allowed and are violations of this rule. Those behaviors include, but are not limited to the list below:

- A. inappropriate behavior as outlined in the blue box of [G201](#),
- B. jumping over the guardrail,
- C. pushing past the FIELD reset person blocking an open gate to get on the FIELD,
- D. reaching into the FIELD and grabbing a ROBOT during a MATCH,
- E. PINNING in excess of 15 seconds,
- F. exploiting the 3-second window after a MATCH described in section [6.5 Scoring](#) to avoid rule violations (e.g. triggering an over-extension that enables

- CAGE points or using a ROBOT'S residual energy to impact an opponent ROBOT on their BARGE),
- G. triggering scoring sensors or otherwise interfering with FMS or FIELD operation,
- H. climbing on the BARGE, and
- I. throwing an ALGAE directly at an opponent ROBOT
- J. deliberately, running an AUTO to disrupt the opponent ALLIANCE'S CAGES.
- K. deliberately, trying to disrupt multiple opponent ALLIANCE'S CAGES during TELEOP.

The Head REFEREE may assign a YELLOW or RED CARD for a single instance of a rule violation such as the examples given in items above, or for multiple instances of any single rule violation. Teams should be aware that any rule in this manual could escalate to a YELLOW or RED CARD. The Head REFEREE has final authority on all rules and violations at an event.

7.3 Pre-MATCH

G301 *Be prompt. A DRIVE TEAM member may not cause significant delays to the start of their MATCH. Causing a significant delay requires both of the following to be true:

- A. The expected MATCH start time has passed, and

Event volunteers communicate schedule delays with teams to the best of their ability. The Pit Display (which is typically located near the Pit Administration desk) shows any event timing delay. Announcements on the FIELD and in the pits also provide information on delays, and any team uncertain of when to queue for a MATCH should communicate with queuing volunteers.

During Qualification MATCHES, the expected start time of the MATCH is the time indicated on the MATCH schedule or the cycle time for current round minus 3 minutes from the end of the previous MATCH (which is reflected on the schedule on the Pit Display), whichever is later.

During Playoff MATCHES, the expected start time of the MATCH is the time indicated on the MATCH schedule or 15 minutes from either ALLIANCE'S previous MATCH, whichever is later.

- B. The DRIVE TEAM has access to the FIELD and is neither MATCH ready nor making a good faith effort, to quickly become MATCH ready.

Teams that have violated [G208](#) or have 1 DRIVE TEAM member present and have informed event staff that their ROBOT will not be participating in the MATCH are considered MATCH ready and not in violation of this rule.

Violation: If a Qualification MATCH, VERBAL WARNING, or if a subsequent violation within the tournament phase, MAJOR FOUL applied to their upcoming MATCH. If the DRIVE TEAM is not MATCH ready within 2 minutes of the VERBAL WARNING/MAJOR FOUL and the Head REFEREE perceives no good faith effort by the DRIVE TEAM to quickly become MATCH ready, DISABLED. If a Playoff MATCH, VERBAL WARNING issued the ALLIANCE, or if an ALLIANCE'S subsequent violation within the tournament phase, MAJOR FOUL applied to their upcoming MATCH. If the ALLIANCE is not MATCH ready within 2 minutes of the VERBAL WARNING having been issued to all 3 teams/MAJOR FOUL and the Head REFEREE perceives no good faith effort by the DRIVE TEAM to quickly become MATCH ready, their ROBOT is DISABLED.

The intent of this rule is to provide an equitable amount of time for both ALLIANCES to prepare for each MATCH and give DRIVE TEAMS grace given extenuating circumstances that cause them to be late.

Once a VERBAL WARNING /MAJOR FOUL is issued, the Head REFEREE starts a 2-minute timer and makes a good faith effort to share the timer's status with the delaying DRIVE TEAM.

Being "MATCH ready" requires that the ROBOT is on the FIELD, in its STARTING CONFIGURATION, and turned on. Additionally, the DRIVE TEAM members must be in their starting positions.

In general, good faith efforts to quickly become MATCH ready are entirely for the purposes of transitioning the ROBOT into a MATCH ready state (i.e. not attempts to significantly alter a ROBOT's capabilities.) Examples of good faith efforts to quickly become MATCH ready include but are not limited to:

- A. walking safely towards the FIELD with a ROBOT that a team is not actively modifying,
- B. applying quick fixes such as tape or cable ties to make the ROBOT compliant with STARTING CONFIGURATION requirements,
- C. waiting for an OPERATOR CONSOLE computer to boot, and
- D. working with FIELD STAFF to get the ROBOT connected to the FIELD.

Examples that are not considered good faith efforts to quickly become MATCH ready include but are not limited to:

- E. a ROBOT not moving to the FIELD,
- F. a ROBOT moving to the FIELD but being actively modified while doing so,
- G. a DRIVE TEAM member remaining on the FIELD once a MATCH is ready to begin (indicated by the green LEDs having turned off),
- H. installing BUMPERS, charging pneumatic systems, or any other ROBOT maintenance not considered a quick fix as described in item B above once on the FIELD,
- I. time-consuming use of alignment devices that are external to the ROBOT (e.g. a DRIVE TEAM could bring and use a measuring tape, as long as there is no delay to the MATCH by doing so), and
- J. repairs more substantial than those described in B.

There are no rules that prohibit use of hand tools (including battery operated tools) while setting up ROBOTS from the FIELD, provided they do not cause significant delay or cause safety concerns.

G302 ***You can't bring/use anything you want.** The only equipment that may be brought to the ARENA for use during a MATCH is listed below. Regardless of if equipment fits criteria below, it may not be employed in a way that breaks any other rules, introduces a safety hazard, blocks visibility for FIELD STAFF or audience members, or jams or interferes with the remote sensing capabilities of another team or the FIELD.

- A. the OPERATOR CONSOLE,
- B. non-powered signaling devices,
- C. reasonable decorative items,
- D. special clothing and/or equipment required due to a disability,
- E. devices used solely for planning, tracking, and communicating strategy within the same designated area (e.g. ALLIANCE AREA),

- F. devices used solely to record gameplay, and
- G. non-powered Personal Protective Equipment (examples include, but aren't limited to, gloves, eye protection, and hearing protection).

Items brought to the ARENA under allowances B-G must meet all following conditions:

- I. do not connect or attach to the OPERATOR CONSOLE, FIELD, or ARENA,
- II. do not connect or attach to another ALLIANCE member (other than items in category G),
- III. do not communicate with anything or anyone outside of the ARENA,
- IV. do not communicate with the TECHNICIAN,
- V. do not include any form of enabled wireless electronic communication with the exception of medically required equipment, and
- VI. do not in any way affect the outcome of a MATCH, other than by allowing the DRIVE TEAM to
 - a. plan or track strategy for the purposes of communication of that strategy to other ALLIANCE members or
 - b. use items allowed per B to communicate with the ROBOT.

Violation: MATCH will not start until the situation is remedied. If discovered or used inappropriately during a MATCH, YELLOW CARD.

Examples of equipment that may be considered a safety hazard in the confined space of the ALLIANCE AREA include, but are not limited to, a step stool or a large signaling device.

Examples of remote sensing capabilities include, but are not limited to, vision systems, acoustic range finders, sonars, and infrared proximity sensors.

Use of imagery that, to a reasonably astute observer, mimics the AprilTags employed on the FIELD is a violation of this rule.

Examples of wireless communication include, but are not limited to, radios, walkie-talkies, cell phones, Bluetooth communications, and Wi-Fi.

G303 *Start your ROBOTS. A ROBOT must meet all following MATCH-start requirements:

- A. it does not pose a hazard to humans, FIELD elements, or other ROBOTS,
- B. has passed initial, complete inspection, i.e. it's compliant with all ROBOT rules (for exceptions regarding Practice MATCHES, see section [10.4 Practice MATCHES](#)),
- C. if modified after initial Inspection, it's compliant with [1104](#),
- D. its BUMPERS overlap their ROBOT STARTING LINE,
- E. it's the only team-provided item left on the FIELD,
- F. it's not attached to, entangled with, or suspended from any FIELD element,
- G. it's confined to its STARTING CONFIGURATION (reference [R102](#) and [R104](#)), and
- H. it fully and solely supports not more than 1 CORAL (as described in section [6.3.4 SCORING ELEMENTS](#)).

Violation: If fix is a quick remedy, the MATCH won't start until all requirements are met. If it is not a quick remedy, DISABLED and, at the discretion of the Head REFEREE, must be re-inspected. If a ROBOT not compliant with part B or C participates, its team receives a RED CARD.

If a ROBOT is BYPASSED prior to the start of the MATCH, the DRIVE TEAM may not remove the ROBOT from the FIELD without permission from the Head REFEREE or the FTA.

For assessment of many of the items listed above, the Head REFEREE is likely to consult with the LRI.

7.4 In-MATCH

Rules in this section pertain to game play once a MATCH begins.

7.4.1 AUTO

The AUTO period is the first 15 seconds of the MATCH, and the FMS blocks any DRIVER control, so ROBOTS operate with only their pre-programmed instructions. Rules in this section apply only during the AUTO period.

G401 *Behind the lines. In AUTO, a DRIVE TEAM member staged behind a HUMAN STARTING LINE may not contact anything in front of that HUMAN STARTING LINE, unless for personal or equipment safety, to press the E-Stop or A-Stop, or granted permission by a Head REFEREE or FTA.

Violation: MINOR FOUL regardless of the number of items contacted.

Pointing, gesturing, or otherwise extending across the HUMAN STARTING LINE such that contact is not made with carpet or other ARENA elements is not a violation of this rule.

An example of an exception for equipment safety is if an OPERATOR CONSOLE starts to fall from, or has already fallen off of, the DRIVER STATION shelf. In that circumstance, DRIVE TEAM members may step forward to catch it or pick it up off the ground and return it to the shelf.

G402 *Let the ROBOT do its thing. In AUTO, a DRIVE TEAM member may not directly or indirectly interact with a ROBOT or an OPERATOR CONSOLE unless for personal safety, OPERATOR CONSOLE safety, or pressing an E-Stop or A-Stop. A HUMAN PLAYER feeding CORAL to their ROBOT is an exception to this rule.

Violation: MINOR FOUL and YELLOW CARD

G403 Limited AUTO opponent interaction. In AUTO, a ROBOT whose BUMPERS are completely across the BARGE ZONE (i.e. to the opposite side of the BARGE ZONE from its ROBOT STARTING ZONE) may not contact an opponent ROBOT (either directly or transitively through a SCORING ELEMENT CONTROLLED by either ROBOT and regardless of who initiates contact).

Violation: MAJOR FOUL and VERBAL WARNING. YELLOW CARD if subsequent violations during the event.

G404 No throwing in AUTO. In AUTO, a HUMAN PLAYER may not enter ALGAE onto the field.

Violation: MINOR FOUL.

G405 No opponents CAGES in AUTO. In AUTO, a ROBOT may not contact the opposing ALLIANCE's CAGES.

Violation: MAJOR FOUL.

7.4.2 SCORING ELEMENTS

G406 *ROBOTS: use SCORING ELEMENTS as directed. A ROBOT may not deliberately use a SCORING ELEMENT in an attempt to ease or amplify a challenge associated with a FIELD element.

Violation: MAJOR FOUL.

Examples include, but are not limited to:
A. launching SCORING ELEMENTS at ROBOTS,

- B. using SCORING ELEMENTS to elevate ROBOTS in an attempt to get on a CAGE, and
- C. positioning SCORING ELEMENTS to impede opponent access to their PROCESSOR.
- D. Placing a CORAL into the PROCESSOR

G407 ***Keep SCORING ELEMENTS in bounds.** A ROBOT may not intentionally eject a SCORING ELEMENT from the FIELD (either directly or by bouncing off a FIELD element or other ROBOT) other than through a PROCESSOR.

Violation: MINOR FOUL. If REPEATED, MAJOR FOUL.

G408 ***Don't abuse SCORING ELEMENTS.** Neither a ROBOT nor a HUMAN PLAYER may damage a SCORING ELEMENT.

Violation: VERBAL WARNING. MAJOR FOUL if REPEATED in any subsequent MATCHES during the event. If via a ROBOT and the Head REFEREE determines that further damage is likely to occur, DISABLED.

Corrective action (such as eliminating sharp edges, removing the damaging MECHANISM, and/or re-inspection) may be required before the ROBOT may compete in subsequent MATCHES.

SCORING ELEMENTS are expected to undergo a reasonable amount of wear and tear as they are handled by ROBOTS, such as scratching or marking. Routinely gouging, tearing off pieces, or marking SCORING ELEMENTS are violations of this rule.

G409 **1 of each at a time.** A ROBOT may not simultaneously CONTROL more than 1 CORAL and 1 ALGAE either directly or transitively through other objects. A ROBOT is in CONTROL of a SCORING ELEMENT if

- A. the SCORING ELEMENT is fully supported by or stuck in, on, or under the ROBOT or
- B. the ROBOT intentionally pushes a SCORING ELEMENT to a desired location or in a preferred direction (i.e. herding).

Violation: MINOR FOUL per additional SCORING ELEMENT. YELLOW CARD if excessive.

Examples of interaction with a SCORING ELEMENT that are not "CONTROL" include, but are not limited to:

- A. "bulldozing" (inadvertent contact with a SCORING ELEMENT while in the path of the ROBOT moving about the FIELD)
- B. "deflecting" (being hit by a SCORING ELEMENT that bounces into or off a ROBOT)
- C. inadvertent contact with a SCORING ELEMENT while attempting to acquire a SCORING ELEMENT from the CORAL STATION.

It is important to design your ROBOT so that it is impossible to inadvertently or unintentionally CONTROL more than the limit.

Excessive violations of CONTROL limits include, but are not limited to, simultaneous CONTROL of 3 or more SCORING ELEMENTS or frequent, greater-than-MOMENTARY CONTROL (i.e. more than twice in a MATCH) of 4 or more SCORING ELEMENTS.

G410 **No de-scoring.** A ROBOT may not de-score a CORAL scored on the opponent's REEF.

Violation: MAJOR FOUL per de-scored CORAL and the opposing ALLIANCE is awarded the CORAL RP.

G411 **Don't put ALGAE on their REEF.** A ROBOT may not deliberately put ALGAE on their opponent's REEF.

Violation: MAJOR FOUL and YELLOW CARD.

- G412** **Only throw CORAL if in your REEF ZONE.** A ROBOT may not launch CORAL unless their BUMPERS are partially in their REEF ZONE.

Violation: MAJOR FOUL.

A CORAL is considered launched if it is shot into the air, kicked across the floor, or thrown in a forceful way.
This rule is not intended to penalize typical movement of CORAL outside an ALLIANCE'S REEF ZONE which come to rest a short distance from the ROBOT.
Examples of such actions could be but are not limited to:

- A. Running an intake in reverse causing a CORAL to travel a short distance from the ROBOT
- B. A ROBOT pushing a CORAL a short distance away in the process of herding it across the FIELD

7.4.3 ROBOT

- G413** ***ROBOTS must be safe.** A ROBOT may not pose an undue hazard to a human, an ARENA element, or another ROBOT in the following ways:

- A. the ROBOT or anything it CONTROLS, e.g. a CORAL, contacts anything outside the FIELD except for MOMENTARY contact inside the CHUTE,
- B. its BUMPERS fail such that a segment completely detaches,
- C. a corner of its ROBOT PERIMETER is exposed,
- D. its team number or ALLIANCE color are indeterminate,
- E. its BUMPERS leave the BUMPER ZONE REPEATEDLY or for more than a MOMENTARY amount of time, or
- F. its operation or design is dangerous or unsafe.

Violation: DISABLED.

Examples of dangerous operation or designs that likely pose undue hazards include, but are not limited to:

- A. uncontrolled motion that cannot be stopped by the DRIVE TEAM,
- B. ROBOT parts "flailing" outside of the FIELD,
- C. ROBOTS dragging their battery, and
- D. ROBOTS that consistently extend outside the FIELD.

Please be conscious of REFEREES and FIELD STAFF working around the ARENA who may be in close proximity to your ROBOT.

- G414** ***Keep your BUMPERS low.** BUMPERS must be in the BUMPER ZONE (see [R405](#)).

Violation: MINOR FOUL.

- G415** **Expansion limits.** A ROBOT may not extend more than 1 ft. 6 in. (~45 cm) beyond the vertical projection of its ROBOT PERIMETER.

If the over-expansion is due to damage and not used for strategic benefit, it is an exception to this rule, and no penalty is imposed.

Violation: MINOR FOUL, or MAJOR FOUL if the over-expansion is used for strategic benefit, including if it impedes or enables a scoring action.

Examples of compliant and non-compliant extensions are shown in [Figure 7-2](#). ROBOT A violates this rule for having an extension that is too long, while ROBOTS B, C, and D do not violate this rule.

Figure 7-2 Examples of compliance and non-compliance of this rule (examples A and B are side views, examples C and D are top views)

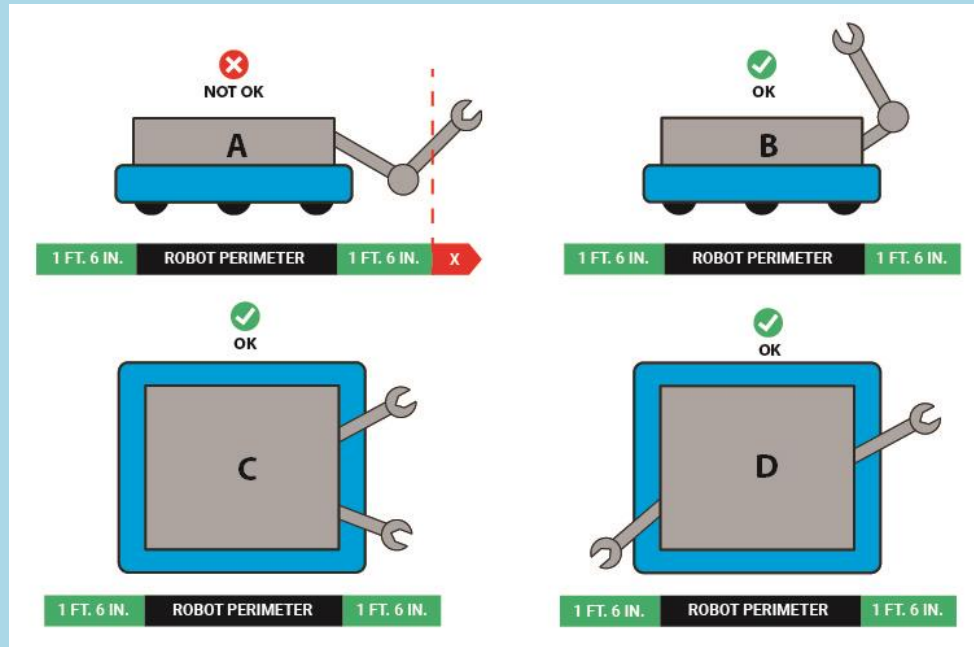

The intent of this rule is to prevent piling on a punitive response to a ROBOT that's already experienced hardship and not leveraging that hardship for gain. Examples for this rule include the following:

- A. a physical device on a team's ROBOT, whose purpose is to restrain their CORAL scoring arm from extending beyond the limit defined in B, breaks after a collision with another ROBOT. Provided the ROBOT does not use the now-too-long extension to score SCORING ELEMENTS, no violation is assigned.
- B. a vertical structural member of a ROBOT breaks at the bottom and rotates out such that it breaches the limit imposed in part B. The ROBOT then parks such that its extension blocks opponent ROBOTS from reaching their PROCESSOR. A MAJOR FOUL is issued.
- C. a latch restraining a launcher MECHANISM from extending above the limit defined in A breaks, allowing the MECHANISM to shift such that it's above the plane of other ROBOTS. The ROBOT uses this new height to get above a defender and score ALGAE in the BARGE. A MAJOR FOUL is issued.

G416 Don't damage the FIELD. A ROBOT may not damage FIELD elements.

Violation: VERBAL WARNING. If the Head REFEREE infers that additional damage is likely, DISABLED. YELLOW CARD for any subsequent damage during the event. Corrective action (such as eliminating sharp edges, removing the damaging MECHANISM, and/or re-inspection) may be required before the ROBOT will be allowed to compete in subsequent MATCHES.

- G417 Watch your FIELD interaction.** A ROBOT is prohibited from the following interactions with FIELD elements with the exception of CAGES (see section [7.4.2 SCORING ELEMENTS](#)).
- A. grabbing,
 - B. grasping,
 - C. attaching to (including the use of a vacuum or hook fastener to anchor to the FIELD carpet),
 - D. becoming entangled with, and
 - E. suspending from.

Violation: MAJOR FOUL, plus YELLOW CARD if REPEATED, or longer than MOMENTARY. If the Head REFEREE infers that damage is likely, DISABLED. Corrective action (such as removing the offending MECHANISM, and/or re-inspection) may be required before the ROBOT will be allowed to compete in subsequent MATCHES.

- G418 An Opponent's CAGES are off-limits in TELEOP.** In TELEOP, A ROBOT may not contact an opponent's CAGE.

Violation: MAJOR FOUL and opposing ALLIANCE is awarded the BARGE RP if a Qualification MATCH.

- G419 ANCHORS are off-limits.** A ROBOT may not contact the ANCHORS. Exceptions are granted for actions that are, MOMENTARY, and inconsequential.

Violation: MAJOR FOUL and the ALLIANCE is ineligible for the BARGE RP if a Qualification MATCH.

- G420 NET and contents are off-limits.** A ROBOT may not contact either NET or any ALGAE scored in a NET.

Violation: MAJOR FOUL. Additional MAJOR FOUL for each ALGAE de-scored.

- G421 1 defender at a time.** A ROBOT may not cross from its side of the FIELD (i.e. containing its REEF) and end on the opponent's side of the FIELD (i.e. containing the opponent REEF) outside and beyond the BARGE ZONES if an ALLIANCE partner ROBOT'S BUMPERS are completely across the BARGE ZONES and on the opponent's side of the FIELD.

Violation: MINOR FOUL, and for every 3 seconds in which the situation is not corrected, a MAJOR FOUL is assessed.

7.4.4 Opponent Interaction

Note, [G422](#), [G423](#), [G424](#) are mutually exclusive. A single ROBOT to ROBOT interaction which violates more than 1 of these rules results in the most punitive penalty, and only the most punitive penalty, being assessed.

- G422 *Stay out of other ROBOTS.** A ROBOT may not use a COMPONENT outside its ROBOT PERIMETER (except its BUMPERS) to initiate contact with an opponent ROBOT inside the vertical projection of the opponent's ROBOT PERIMETER.

Violation: MINOR FOUL.

For the purposes of this rule, "initiate contact" requires movement towards an opponent ROBOT.

In a collision, it's possible for both ROBOTS to initiate contact.

- G423 *This isn't combat robotics.** A ROBOT may not damage or functionally impair an opponent ROBOT in either of the following ways:

- A. deliberately.

- B. regardless of intent, by initiating contact, either directly or transitively via a SCORING ELEMENT CONTROLLED by the ROBOT, inside the vertical projection of an opponent's ROBOT PERIMETER.

Damage or functional impairment because of contact with a tipped-over opponent ROBOT, which is not perceived by a REFEREE to be deliberate, is not a violation of this rule.

Violation: MAJOR FOUL and YELLOW CARD, or if opponent ROBOT is unable to drive, then MAJOR FOUL and RED CARD.

FIRST Robotics Competition can be a full-contact competition and may include rigorous game play. While this rule aims to limit severe damage to ROBOTS, teams should design their ROBOTS to be robust.

Examples of violations of this rule include, but are not limited to:

- A. A ROBOT leaves an arm extended, spins around to change course, and unintentionally hits and damages a COMPONENT inside the ROBOT PERIMETER of a nearby opponent ROBOT.
- B. A ROBOT, in the process of trying to quickly reverse direction, tips up on a single pair of wheels, lands atop an opponent ROBOT, and damages a COMPONENT inside that opponent's ROBOT PERIMETER.
- C. A ROBOT high-speed rams and/or REPEATEDLY smashes an opponent ROBOT and causes damage. The REFEREE infers that the ROBOT was deliberately trying to damage the opponent's ROBOT.

Examples of functionally impairing another ROBOT include, but are not limited to:

- D. opening an opponent's relief valve such that the opponent's air pressure drops and
- E. powering off an opponent's ROBOT (this example also clearly results in a RED CARD because the ROBOT is no longer able to drive).

At the conclusion of the MATCH, the Head REFEREE may elect to visually inspect a ROBOT to confirm violations of this rule made during a MATCH and remove the violation if the damage cannot be verified.

For the purposes of this rule, "initiating contact" requires movement towards an opponent ROBOT.

In a collision, it's possible for both ROBOTS to initiate contact.

"Unable to drive" means that because of the incident, the DRIVER can no longer drive to a desired location in a reasonable time (generally). For example, if a ROBOT can only move in circles, or can only move extremely slowly, the ROBOT is considered unable to drive.

- G424** ***Don't tip or entangle.** A ROBOT may not deliberately, attach to, tip, or entangle with an opponent ROBOT.

Violation: MAJOR FOUL and YELLOW CARD, or if CONTINUOUS or opponent ROBOT is unable to drive, then MAJOR FOUL and RED CARD.

Examples of violations of this rule include, but are not limited to:

- A. using a wedge-like MECHANISM to tip over opponent ROBOTS,

- B. making BUMPER-to-BUMPER contact with an opponent ROBOT that is attempting to right itself after previously falling over and causing them to fall over again, and
- C. causing an opponent ROBOT to tip over by contacting the ROBOT after it starts to tip if, in the judgement of the REFEREE, that contact could have been avoided.

Tipping as an unintended consequence of normal ROBOT to ROBOT interaction, including single BUMPER to BUMPER hits that result in a ROBOT tipping, is not a violation of this rule.

"Unable to drive" means that because of the incident, the DRIVER can no longer drive to a desired location in a reasonable time (generally). For example, if a ROBOT can only move in circles, or can only move extremely slowly, the ROBOT is considered unable to drive.

G425 ***There's a 3-count on PINS.** A ROBOT may not PIN an opponent's ROBOT for more than 3 seconds. A ROBOT is PINNING if it is preventing the movement of an opponent ROBOT by contact, either direct or transitive (such as against a FIELD element). A PIN count ends once any of the following criteria below are met:

- A. the ROBOTS have separated by at least 6 ft. (~183 cm) from each other for more than 3 seconds,
- B. either ROBOT has moved 6 ft. from where the PIN initiated for more than 3 seconds, or
- C. the PINNING ROBOT gets PINNED.

For criteria A, the PIN count pauses once ROBOTS are separated by 6 ft. until either the PIN ends or the PINNING ROBOT moves back within 6 ft., at which point the PIN count is resumed.

For criteria B, the PIN count pauses once either ROBOT has moved 6ft from where the PIN initiated until the PIN ends or until both ROBOTS move back within 6ft., at which point the PIN count is resumed.

Violation: MINOR FOUL, and for every 3 seconds in which the situation is not corrected, a MAJOR FOUL is assessed.

A team's desired direction of travel is not a consideration when determining if a ROBOT is PINNED.

G426 ***Don't collude with your partners to shut down major parts of game play.** 2 or more ROBOTS that appear to a REFEREE to be working together may not isolate or close off any major element of MATCH play.

Violation: MAJOR FOUL, and for every 3 seconds in which the situation is not corrected, a MAJOR FOUL is assessed.

Examples of violations of this rule include, but are not limited to:

- A. shutting down access to all SCORING ELEMENTS,
- B. quarantining all opponents to a small area of the FIELD,
- C. blocking all access to the opponent's PROCESSOR, and
- D. blocking all access to the opponent's CAGES.

A single ROBOT blocking access to a particular area of the FIELD is not a violation of this rule.

2 ROBOTS independently playing defense on 2 opponent ROBOTS is not a violation of this rule.

G427 ZONE protection. A ROBOT may not contact, directly or transitively through a SCORING ELEMENT, an opponent ROBOT partially inside the opponent's BARGE ZONE or REEF ZONE regardless of who initiates contact.

Violation: MAJOR FOUL.

ROBOTS that contact each other while in their respective BARGE ZONES may result in a violation for both ALLIANCES

G428 CAGE protection. A ROBOT may not contact, directly or transitively through a SCORING ELEMENT, an opponent ROBOT in contact with an opponent CAGE during the last 20 seconds regardless of who initiates contact.

Violation: MAJOR FOUL and the opponent ALLIANCE is awarded the BARGE RP

7.4.5 Human

G429 *No wandering. A DRIVE TEAM member must remain in their designated area as follows:

- A. DRIVERS and COACHES may not contact anything outside their ALLIANCE AREA,
- B. a DRIVER must use the OPERATOR CONSOLE in the DRIVER STATION to which they are assigned, as indicated on the team sign,
- C. a HUMAN PLAYER may not contact anything outside the area in which they started the MATCH (i.e. the ALLIANCE AREA or PROCESSOR AREA), and
- D. a TECHNICIAN may not contact anything outside their designated area.

Exceptions are granted as follows:

- E. for a HUMAN PLAYER partially outside the ALLIANCE or PROCESSOR AREA,
- F. in cases concerning safety, and
- G. for actions that are inadvertent, MOMENTARY, and inconsequential.

Violation: MINOR FOUL

An intent of item B is to prevent unsafe situations where long tethers to OPERATOR CONSOLE devices increase tripping hazards as the operator moves about the ALLIANCE AREA. In the interest of avoiding nuisance penalties associated with a DRIVE TEAM member stepping outside of a prescribed area, we prefer to offer a general guideline as to what it means to use the OPERATOR CONSOLE in the ALLIANCE AREA. Provided the DRIVE TEAM member is within close proximity of their DRIVER STATION, there will be no repercussions. However, a DRIVE TEAM member located more than approximately half a DRIVER STATION width away from their own DRIVER STATION while using their OPERATOR CONSOLE is likely violating this rule.

G430 *COACHES and other teams: hands off the controls. A ROBOT shall be operated only by the DRIVERS and/or HUMAN PLAYERS of that team. A COACH activating their E-Stop or A-Stop is the exception to this rule.

Violation: MAJOR FOUL. RED CARD if greater-than-MOMENTARY.

Exceptions may be made before a MATCH for major conflicts, e.g. religious holidays, major testing, transportations issues, etc.

G431 *DRIVE TEAMS, watch your reach. A DRIVE TEAM member may not extend into the CHUTE.

Violation: MINOR FOUL.

G432 ***Humans: use SCORING ELEMENTS as directed.** A DRIVE TEAM member may not deliberately use a SCORING ELEMENT in an attempt to ease or amplify a challenge associated with a FIELD element.

Violation: MAJOR FOUL.

An example of a violation of this rule is if a HUMAN PLAYER uses an ALGAE to disrupt an opponent ROBOT.

G433 ***SCORING ELEMENT delivery.** SCORING ELEMENTS may only be entered onto the FIELD as follows:

- A. CORAL may only be introduced to the FIELD by a HUMAN PLAYER or DRIVER through the CORAL STATION and
- B. ALGAE may only be entered onto the FIELD by a HUMAN PLAYER in their PROCESSOR AREA.

Violation: MAJOR FOUL.

G434 ***COACHES, SCORING ELEMENTS are off limits.** COACHES may not touch SCORING ELEMENTS, unless for safety purposes.

Violation: MINOR FOUL.

7.5 Post-MATCH

G501 ***Leave promptly.** A DRIVE TEAM member may not cause significant or multiple delays to the start of a subsequent MATCH, scheduled break content, or other FIELD activities.

Violation: VERBAL WARNING. YELLOW CARD if subsequent violations at any point during the event.



8 ROBOT Construction Rules (R)

The rules listed below explicitly address legal parts and materials and how those parts and materials may be used on a REEFSCAPE ROBOT. A ROBOT is an electromechanical assembly built by the *FIRST* Robotics Competition team to play the current season's game and includes all the basic systems required to be an active participant in the game –power, communications, control, BUMPERS, and movement about the FIELD. A BUMPER is a protective assembly designed to attach to the exterior of the ROBOT and constructed as specified in section [8.4 BUMPER Rules](#).

There are many reasons for the structure of the rules, including safety, reliability, parity, creation of a reasonable design challenge, adherence to professional standards, impact on the competition, and compatibility with the [Kit of Parts \(KOP\)](#). The KOP is the collection of items listed on the current season's Kickoff Kit Checklists, distributed to the team via *FIRST* Choice in the current season, or paid for completely (except shipping) with a Product Donation Voucher (PDV) from the current season.

Another intent of these rules is to have all energy sources and active actuation systems on the ROBOT (e.g. batteries, compressors, motors, servos, cylinders, and their controllers) drawn from a well-defined set of options. This is to ensure that all teams have access to the same actuation resources and that the INSPECTORS are able to accurately and efficiently assess the legality of a given part.

ROBOTS are made up of COMPONENTS and MECHANISMS. A COMPONENT is any part in its most basic configuration, which cannot be disassembled without damaging or destroying the part or altering its fundamental function. A MECHANISM is an assembly of COMPONENTS that provide specific functionality on the ROBOT. A MECHANISM can be disassembled (and then reassembled) into individual COMPONENTS without damage to the parts.

Many rules in this section reference Commercial-Off-The-Shelf (COTS) items. A COTS item must be a standard (i.e. not custom order) part commonly available from a VENDOR for all teams for purchase. To be a COTS item, the COMPONENT or MECHANISM must be in an unaltered, unmodified state (with the exception of installation or modification of any software). Items that are no longer commercially available but are functionally equivalent to the original condition as delivered from the VENDOR are considered COTS and may be used.

Example 1: A team orders 2 ROBOT grippers from RoboHands Corp. and receives both items. They put 1 in their storeroom and plan to use it later. Into the other, they drill "lightening holes" to reduce weight. The first gripper is still classified as a COTS item, but the second gripper is now a FABRICATED ITEM, as it has been modified.

Example 2: A team obtains openly available blueprints of a drive module commonly available from Wheels-R-U's Inc. and has local machine shop "We-Make-It, Inc." manufacture a copy of the part for them. The produced part is not a COTS item, because it is not commonly carried as part of the standard stock of We-Make-It, Inc.

Example 3: A team obtains openly available design drawings from a professional publication during the pre-season and uses them to fabricate a gearbox for their ROBOT during the build period following Kickoff. The design drawings are considered a COTS item and may be used as "raw material" to fabricate the gearbox. The finished gearbox itself would be a FABRICATED ITEM, and not a COTS item.

Example 4: A COTS part that has non-functional label markings added would still be considered a COTS part, but a COTS part that has device-specific mounting holes added is a FABRICATED ITEM.

Example 5: A team has a COTS single-board processor version 1.0, which can no longer be purchased. Only the COTS single-board processor version 2.0 may be purchased. If the COTS single-board processor version 1.0 is functionally equivalent to its original condition, it may be used.

Example 6: A team has a COTS gearbox which has been discontinued. If the COTS gearbox is functionally equivalent to its original condition, it may be used.

A **VENDOR** is a legitimate business source for COTS items that satisfies all the following criteria:

- A. has a Federal Tax Identification number. In cases where the **VENDOR** is outside of the United States, they must possess an equivalent form of registration or license with the government of their home nation that establishes and validates their status as a legitimate business licensed to operate within that country.
- B. is not a “wholly owned subsidiary” of a *FIRST* Robotics Competition team or collection of teams. While there may be some individuals affiliated with both a team and the **VENDOR**, the business and activities of the team and **VENDOR** must be completely separable.
- C. should maintain sufficient stock or production capability so they are able to ship any general (i.e., non-*FIRST* unique) product within 5 business days of receiving a valid purchase request. It is recognized that certain unusual circumstances (such as such as a global supply chain disruption and/or 1,000 *FIRST* teams all ordering the same part at once from the same **VENDOR**) may cause atypical delays in shipping due to backorders for even the largest **VENDORS**. Such delays due to higher-than-normal order rates are excused. This criterion may not apply to custom-built items from a source that is both a **VENDOR** and a fabricator.

For example, a **VENDOR** may sell flexible belting that the team wishes to procure to use as treads on their drive system. The **VENDOR** cuts the belting to a custom length from standard shelf stock that is typically available, welds it into a loop to make a tread, and ships it to a team. The fabrication of the tread takes the **VENDOR** 2 weeks. This would be considered a FABRICATED ITEM, and the 2-week ship time is acceptable. Alternately, the team may decide to fabricate the treads themselves. To satisfy this criterion, the **VENDOR** would just have to ship a length of belting from shelf stock (i.e. a COTS item) to the team within 5 business days and leave the welding of the cuts to the team.

- D. makes their products available to all *FIRST* Robotics Competition teams. A **VENDOR** must not limit supply or make a product available to just a limited number of *FIRST* Robotics Competition teams.

The intent of this definition is to be as inclusive as possible to permit access to all legitimate sources, while preventing ad hoc organizations from providing special-purpose products to a limited subset of teams in an attempt to circumvent the cost accounting rules.

FIRST desires to permit teams to have the broadest choice of legitimate sources possible, and to obtain COTS items from the sources that provide them with the best prices and level of service available. Teams also need to protect against long delays in availability of parts that will impact their ability to complete their

ROBOT. The build season is brief, so the VENDOR must be able to get their product, particularly *FIRST* unique items, to a team in a timely manner.

Ideally, chosen VENDORS should have national distributors (e.g. Home Depot, Lowes, MSC, McMaster-Carr, etc.). Remember, *FIRST* Robotics Competition events are not always near home – when parts fail, local access to replacement materials is often critical.

A FABRICATED ITEM is any COMPONENT or MECHANISM that has been altered, built, cast, constructed, concocted, created, cut, heat treated, machined, manufactured, modified, painted, produced, surface coated, or conjured partially or completely into the final form in which it will be used on the ROBOT.

Note that it is possible for an item (typically raw materials) to be neither COTS nor a FABRICATED ITEM. For example, a 20 ft. (~610 cm) length of aluminum which has been cut into 5 ft. (~152 cm) pieces by the team for storage or transport is neither COTS (it's not in the state received from the VENDOR), nor a FABRICATED ITEM (the cuts were not made to advance the part towards its final form on the ROBOT).

Teams may be asked to provide documentation proving the legality of non-REEFSCAPE KOP items during inspection where a rule specifies limits for a legal part (e.g. pneumatic items, current limits, COTS electronics, etc.).

Some of these rules make use of English unit requirements for parts. If your team has a question about a metric-equivalent part's legality, please e-mail your question to the *FIRST* Robotics Competition Kit of Parts team at frcparts@firstinspires.org for an official ruling. To seek approval for alternate devices for inclusion in future *FIRST* Robotics Competition seasons, please contact the Kit of Parts team at frcparts@firstinspires.org with item specifications.

Teams should acknowledge the support provided by the corporate sponsors and mentors with an appropriate display of their school and sponsors names and/or logos (or the name of the supporting youth organization, if appropriate).

FIRST Robotics Competition can be a full-contact competition and may include rigorous game play. While the rules aim to limit severe damage to ROBOTS, teams should design their ROBOTS to be robust.

8.1 General ROBOT Design

R101 ***ROBOT PERIMETER must be fixed.** The ROBOT (excluding BUMPERS) must have a ROBOT PERIMETER, contained within the BUMPER ZONE and established while in the ROBOT'S STARTING CONFIGURATION, that is comprised of fixed, non-articulated structural elements of the ROBOT. Minor protrusions no greater than ¼ in. (~6 mm) such as bolt heads, fastener ends, weld beads, and rivets are not considered part of the ROBOT PERIMETER.

To determine the ROBOT PERIMETER, wrap a piece of string around the outer most parts of the ROBOT (excluding BUMPERS) at the BUMPER ZONE described in [R405](#) and pull it taut. The string outlines the ROBOT PERIMETER.

Example: A ROBOT'S chassis is shaped like the letter 'U', with a large gap between chassis elements on the front of the ROBOT. When wrapping a taut string around this chassis, the string extends across the gap and the resulting ROBOT PERIMETER is a rectangle with 4 sides.

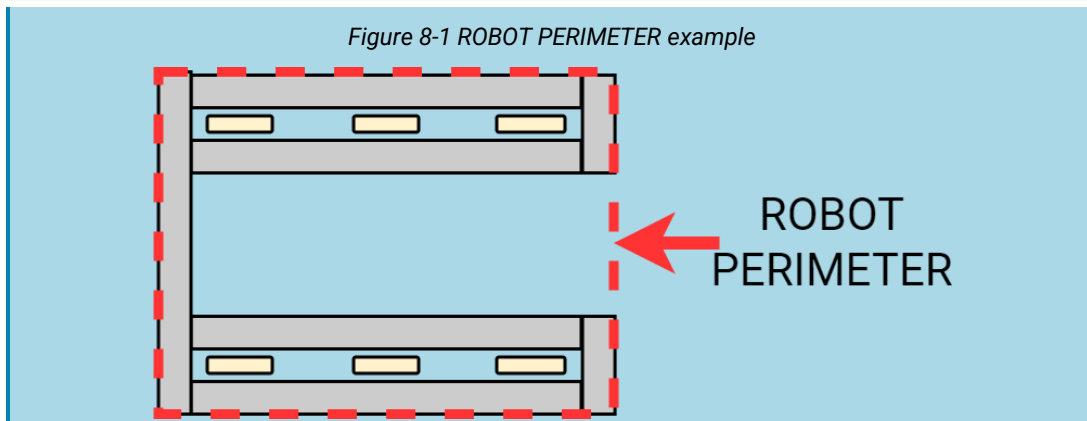

- R102** ***STARTING CONFIGURATION – no overhang.** In the STARTING CONFIGURATION (the physical configuration in which a ROBOT starts a MATCH), no part of the ROBOT shall extend outside the vertical projection of the ROBOT PERIMETER, with the exception of its BUMPERS and minor protrusions such as bolt heads, fastener ends, rivets, cable ties, etc.

If a ROBOT is designed as intended and each side is pushed up against a vertical wall (in STARTING CONFIGURATION and with BUMPERS removed), only the ROBOT PERIMETER (or minor protrusions) will be in contact with the wall.

The allowance for minor protrusions in this rule is intended to allow protrusions that are both minor in extension from the ROBOT PERIMETER and cross-sectional area.

If a ROBOT uses interchangeable MECHANISMS per [I103](#), Teams should be prepared to show compliance with this rule and [R105](#) in all configurations.

- R103** ***ROBOT weight limit.** The ROBOT weight must not exceed 115 lbs. (~52 kg). When determining weight, the basic ROBOT structure and all elements of all additional MECHANISMS that might be used in a single configuration of the ROBOT shall be weighed together (see [I103](#)).

For the purposes of determining compliance with the weight limitations, the following items are excluded:

- A. ROBOT BUMPERS,
- B. ROBOT battery and its associated half of the Anderson cable quick connect/disconnect pair (including no more than 12 in. (~30 cm) of cable per leg, the associated cable lugs, connecting bolts, and insulation), and
- C. tags used for location detection systems if provided by the event.

- R104** **STARTING CONFIGURATION – max size.** A ROBOT'S STARTING CONFIGURATION may not have a ROBOT PERIMETER greater than 120 in. (~304 cm) and may not be more than 3 ft. 6 in. (~106 cm) tall.

Be sure to consider the size of the ROBOT on its cart to make sure it will fit through doors. Also consider the size of the ROBOT to ensure that it will fit into a shipping crate, vehicle, etc.

Note that rules contained in section [8.4 BUMPER Rules](#) may impose additional restrictions on ROBOT design.

- R105** **ROBOT extension limit.** ROBOTS may not extend more than 1 ft. 6 in. (~457 mm) beyond the vertical projection of their ROBOT PERIMETER.

Figure 8-2 ROBOT PERIMETER extension

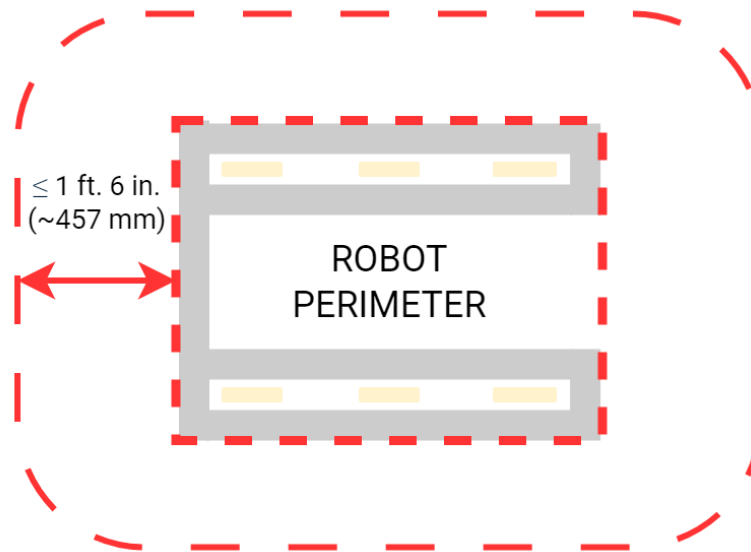

Teams should expect to have to demonstrate a ROBOT'S ability to constrain itself per above during inspection. Constraints may be implemented with either hardware or software.

See section [7.4.3 ROBOT](#) for height and extension restrictions for various areas of the FIELD.

8.2 ROBOT Safety & Damage Prevention

- R201** ***No digging into carpet.** Traction devices must not have surface features that could damage the ARENA (e.g. metal, sandpaper, inflexible studs, cleats, hook-loop fasteners or similar attachments). Traction devices include all parts of the ROBOT that are designed to transmit any propulsive and/or braking forces between the ROBOT and FIELD carpet.
- R202** ***No exposed sharp edges.** Protrusions from the ROBOT and exposed surfaces on the ROBOT shall not pose hazards to the ARENA elements (including SCORING ELEMENTS) or people.
- R203** ***General safety.** ROBOT parts shall not be made from hazardous materials, be unsafe, cause an unsafe condition, or interfere with the operation of other ROBOTS.

Examples of items that will violate this rule include (but are not limited to):

- A. shields, curtains, or any other devices or materials designed or used to obstruct or limit the vision of any DRIVE TEAM members and/or interfere with their ability to safely control their ROBOT,
- B. speakers, sirens, air horns, or other audio devices that generate sound at a level sufficient to be a distraction,
- C. any devices or decorations specifically intended to jam or interfere with the remote sensing capabilities of another ROBOT, including vision systems, acoustic range finders, sonars, infrared proximity detectors, etc. (e.g. including imagery on your ROBOT that utilizes or closely mimics 36h11 AprilTags),
- D. exposed lasers other than Class I,
- E. flammable gasses,

- F. any device intended to produce flames or pyrotechnics,
- G. hydraulic fluids or hydraulic items,
- H. switches or contacts containing liquid mercury,
- I. circuitry used to create voltages in excess of 24 Volts,
- J. any ballast not secured sufficiently, including loose ballast e.g. sand, ball bearings, etc., such that it may become loose during a MATCH,
- K. exposed, untreated hazardous materials (e.g. lead weights) used on the ROBOT. These materials may be permitted if painted, encapsulated, or otherwise sealed to prevent contact. These materials may not be machined in any way at an event.
- L. tire sealant, and
- M. high intensity light sources used on the ROBOT (e.g. super bright LED sources marketed as 'military grade' or 'self-defense') may only be illuminated for a brief time while targeting and may need to be shrouded to prevent any exposure to participants. Complaints about the use of such light sources will be followed by re-inspection and possible disablement of the device.

R204 ***Leave SCORING ELEMENTS at the FIELD.** ROBOTS must allow removal of SCORING ELEMENTS from the ROBOT and the ROBOT from FIELD elements while DISABLED and powered off.

ROBOTS will not be re-enabled after the MATCH, so teams must be sure that SCORING ELEMENTS and ROBOTS can be quickly, simply, and safely removed.
Teams are encouraged to consider [G501](#) when developing their ROBOTS.

R205 ***Don't contaminate the FIELD.** Lubricants may be used only to reduce friction within the ROBOT. Lubricants must not contaminate the FIELD or other ROBOTS.

R206 ***Don't damage SCORING ELEMENTS.** ROBOT elements likely to come in contact with a SCORING ELEMENT shall not pose a significant hazard to the SCORING ELEMENT.

SCORING ELEMENTS are expected to undergo a reasonable amount of wear and tear as they are handled by ROBOTS, such as scratching or marking. Gouging, tearing off pieces, or routinely marking SCORING ELEMENTS are violations of this rule.

8.3 Budget Constraints & Fabrication Schedule

R301 ***Individual item cost limit.** No individual, non-KOP item or software shall have a Fair Market Value (FMV) that exceeds \$600 USD. The total cost of COMPONENTS purchased in bulk may exceed \$600 USD as long as the cost of an individual COMPONENT does not exceed \$600 USD.

Teams should be ready to show INSPECTORS documentation of FMV for any COMPONENTS that appear to be in the range of the \$600 USD limit.

The Analog Devices IMU MXP Breakout Board, P/N ADIS16448, does not have a published FMV. This device is considered to comply with this rule regardless of its true FMV.

The FMV of a COTS item is its price defined by a VENDOR for the part or an identical functional replacement. This price must be generally available to all FIRST Robotics Competition teams throughout the build and competition season (i.e. short-term sale prices or coupons do not reflect FMV), however teams are

only expected to make a good faith effort at determining the item price and are not expected to monitor prices of ROBOT items throughout the season. The FMV is the cost of the item itself and does not include any duties, taxes, tariffs, shipping, or other costs that may vary by locality.

The FMV of COTS software is the price, set by the VENDOR, to license the software (or piece of the software) that runs on the ROBOT for the period from Kickoff to the end of the *FIRST* Championship. The FMV of software licensed free-of-cost, including through the Virtual KOP, for use on the ROBOT is \$0.

The FMV of FABRICATED parts is the value of the material and/or labor, except for labor provided by team members (including sponsor employees who are members of the team), members of other teams, and/or event provided machine shops. Material costs are accounted for as the cost of any purchasable quantity that can be used to make the individual part (i.e. the purchasable raw material is larger than the FABRICATED part).

Example 1: A team orders a custom bracket made by a company to the team's specification. The company's material cost and normally charged labor rate apply.

Example 2: A team receives a donated sensor. The company would normally sell this item for \$450 USD, which is therefore its FMV.

Example 3: A team purchases titanium tube stock for \$400 USD and has it machined by a local machine shop. The machine shop is not considered a team sponsor but donates 2 hours of expended labor anyway. The team must include the estimated normal cost of the labor as if it were paid to the machine shop and add it to the \$400 USD.

Example 4: A team purchases titanium tube stock for \$400 USD and has it machined by a local machine shop that is a recognized sponsor of the team. If the machinists are considered members of the team, their labor costs do not apply. The total applicable cost for the part would be \$400 USD.

It is in the best interests of the teams and *FIRST* to form relationships with as many organizations as possible. Recognizing supporting companies as sponsors of, and members in, the team is encouraged, even if the involvement of the sponsor is solely through the donation of fabrication labor.

Example 5: A team purchases titanium tube stock for \$400 USD and has it machined by another team. The total applicable cost for the part would be \$400 USD.

Example 6: A team purchases a widget at a garage sale or online auction for \$300, but it's available for sale from a VENDOR for \$700. The FMV is \$700.

If a COTS item is part of a modular system that can be assembled in several possible configurations, then each individual module must fit within the price constraints defined in this rule.

If the modules are designed to assemble into a single configuration, and the assembly is functional in only that configuration, then the total cost of the complete assembly including all modules must fit within the price constraints defined in this rule.

In summary, if a VENDOR sells a system or a kit, a team must use the entire system/kit FMV and not the value of its COMPONENT pieces.

Example 7: VENDOR A sells a gearbox that can be used with a number of different gear sets, and can mate with 2 different motors they sell. A team purchases the gearbox, a gear set, and a motor, then assembles them together. Each part is treated separately for the purpose of determining FMV since the purchased pieces can each be used in various configurations.

Example 8: VENDOR B sells a robotic arm assembly that a team wants to use. However, it costs \$630 USD, so they cannot use it. The VENDOR sells the “hand”, “wrist”, and “arm” as separate assemblies, for \$210 USD each. A team wishes to purchase the 3 items separately, then reassemble them. This would not be legal, as they are really buying and using the entire assembly, which has a Fair Market Value of \$630 USD.

Example 9: VENDOR C sells a set of wheels or wheel modules that are often used in groups of 4. The wheels or modules can be used in other quantities or configurations. A team purchases 4 and uses them in the most common configuration. Each part is treated separately for the purpose of determining FMV, since the purchased pieces can be used in various configurations.

R302 ***MAJOR MECHANISM, from this year only.** MAJOR MECHANISMS, as defined in [101](#), created before Kickoff are not permitted.

Neither this rule nor the language in this blue box define specific thresholds for how much of a MAJOR MECHANISM must be constructed after Kickoff. This rule expects and requires the team’s honest assessment of whether they built the MAJOR MECHANISMS of their ROBOT after Kickoff.

Attempts to exploit loopholes in the definition of MAJOR MECHANISM in order to bypass this requirement are in the spirit of neither this rule nor *FIRST* Robotics Competition. Examples of exploitation include:

- A. Pre-assembling significant portions of a MAJOR MECHANISM prior to Kickoff and attaching those assemblies together post-Kickoff
- B. Removing a small COMPONENT of a MAJOR MECHANISM prior to Kickoff such that it is no longer a MAJOR MECHANISM and replacing it after Kickoff.

R303 ***Create new designs and software, unless they’re public.** ROBOT software and designs created before Kickoff are only permitted if the source files (complete information sufficient to produce the design) are available publicly prior to Kickoff.

Example 1: A team realizes that the transmission designed and built in the fall perfectly fits their need for a transmission to drive the ROBOT arm. They build an exact copy of the transmission from the original design plans and bolt it to the ROBOT. This would be prohibited, as the transmission – although made during the competition season – was built from detailed designs developed prior to Kickoff.

Example 2: A team developed an omni-directional drive system for the 2019 competition. In July 2019 they refined and improved the control software, written in C++, to add more precision and capabilities. They decided to use a similar system for the REEFSCAPE competition. They copied large sections of

unmodified code over into the control software of the new ROBOT, also written in C++. This would be a violation of the schedule constraint and is not allowed.

Example 3: The same team decides to use LabVIEW as their software environment for REEFSCAPE. Following Kickoff, they use the previously developed C++ code as a reference for the algorithms and calculations required to implement their omni-directional control solution. Because they developed new LabVIEW code as they ported over their algorithms, this is permitted.

Example 4: A different team develops a similar solution during the fall and plans to use the developed software on their competition ROBOT. After completing the software, they post it in a generally accessible public forum and make the code available to all teams. Because they have made their software publicly available before Kickoff, they can use it on their ROBOT.

Example 5: A team develops a transmission prior to Kickoff. After completing the project, they publish the CAD files on a generally accessible public forum and make them available to all teams. Because they have made the design publicly available before Kickoff, they can use the design to create an identical transmission, fabricated after Kickoff, for use on their REEFSCAPE ROBOT.

- R304** *During an event, only work during pit hours. During an event a team is attending (regardless of whether the team is physically at the event location), the team may neither work on nor practice with their ROBOT or ROBOT elements outside of the hours that pits are open, with the following exceptions:
- OPERATOR CONSOLES, BUMPERS, battery assemblies (as described in [R103-B](#)),
 - COTS items with minor modifications (attachment of connectors, assembly of COTS items per manufacturer instructions, labeling or decoration, etc.)
 - software development, and
 - charging batteries.

For the purposes of this rule, official events begin as follows:

- Regionals, District Championships, and *FIRST* Championship: at the start of the first designated load-in period, according to the Public Schedule. If the Public Schedule is not available or there is no designated load-in period, the events begin at 4pm on the day prior to pits opening.
- District Events: when pits open

Examples of activity prohibited by this rule include:

- working on the ROBOT at the team's shop after load-in for the event has begun,
- working on ROBOT parts at night at the team's hotel, and
- running a 3D printer or other automated manufacturing process overnight producing ROBOT parts.

Note that [E107](#) and [E401](#) impose additional restrictions on work done on the ROBOT or ROBOT materials while attending an event.

This rule is intended to increase equity between teams with significant travel to an event and those nearby (close teams would otherwise have an advantage by being able to work on their ROBOT, in their shop, until it's time to go to the event).

8.4 BUMPER Rules

A BUMPER is a required assembly which attaches to the ROBOT frame. BUMPERS protect ROBOTS from damaging/being damaged by other ROBOTS and FIELD elements.

A BUMPER guide providing additional information on materials and design based on historical best practices may be found under the Mechanical Resources section of the [Technical Resources page](#). Teams may also reference the [KitBot Instructions](#) for a detailed step-by-step on how to build bumpers for the KitBot.

All dimensions specified in this section are nominal and will be measured during inspection with a tolerance of $\frac{1}{4}$ in. (~6 mm) unless otherwise specified. This means that maximums specified have a tolerance of $+\frac{1}{4}$ in. and minimums specified have a tolerance of $-\frac{1}{4}$ in. Teams are encouraged to design to the nominal dimension and reserve the tolerance for unexpected deviation such as manufacturing error or tolerance stack-up.

R401 *BUMPERS all around. ROBOTS are required to use BUMPERS to protect the entire ROBOT PERIMETER. Gaps of less than $1\frac{1}{4}$ in. (~31 mm) between adjacent segments are permitted as long as all corners are filled per [R406](#).

Figure 8-3 BUMPER coverage requirements

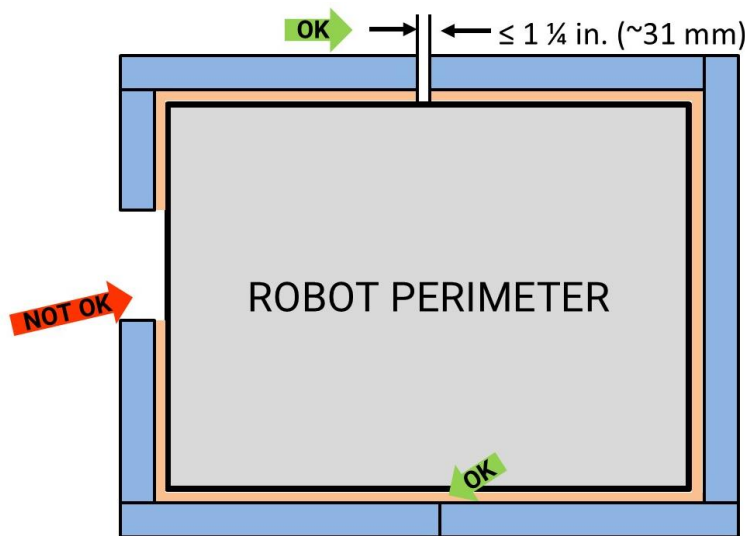

R402 *BUMPER construction. BUMPERS must consist of the following:

- A. Padding – A minimum of $2\frac{1}{4}$ in. (~58 mm) depth of foam padding, at least $4\frac{1}{2}$ in. (~114 mm) tall consisting of solid blocks, sheets, or stacked rods of one or more of the following materials:
 - i. Pool noodles (hollow or solid) or backer rod
 - ii. Solid polyethylene closed cell foam with density between 1.5 and 3 lb./ft.³ (~24 to 48 kg/m³)
 - iii. Solid EVA closed cell foam with density between 2 and 6 lb./ft.³ (~32 to 96 kg/m³)
 - iv. Foam floor tiles

Multiple types, shapes, and/or layers of foam may be used within a single BUMPER.

Teams should be prepared to provide information about the padding material used in their BUMPERS. Teams do not need to have a separate

material sample or expose padding for direct inspection to show compliance with this rule.

- B. Backing – A backer at least 4 ½ in. (~115 mm) tall which supports the padding (i.e. padding is not cantilevered other than in corners) and facilitates installation and removal of the BUMPER from the ROBOT (as noted in [R410](#)). Additional elements may be added to strengthen the backing, fill space between the BUMPER and ROBOT frame, or serve as part of the attachment system.

Figure 8-4 BUMPER backing supporting padding

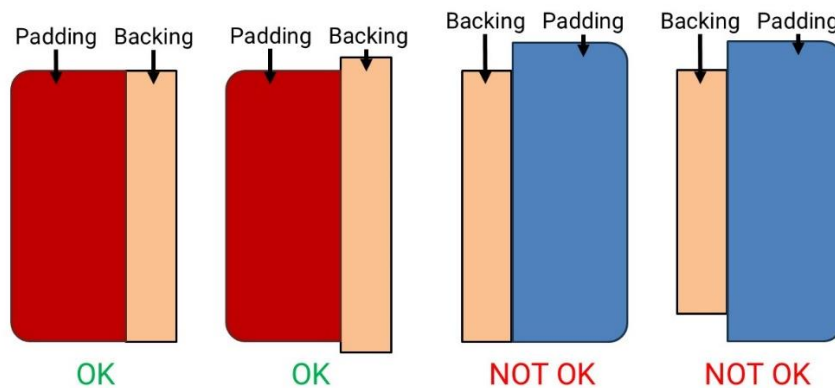

- C. Cover – Fabric (as noted in [G411](#)) which covers all outward, upward and downward facing surfaces such that no padding is exposed to interaction with the FIELD or other ROBOTS.
- D. Fastening System – BUMPERS must attach to the ROBOT PERIMETER with a rigid fastening system to form a tight, robust connection to the main structure/frame (e.g. not attached with hook-and-loop tape, tape, or cable ties). The fastening system must be designed to withstand vigorous game play. All removable fasteners (e.g. bolts, locking pins, quick release pins, etc.) may be considered part of either the BUMPERS or ROBOT for determination of weight per [R103](#) and [R408](#).

The BUMPER Rules provide teams significant freedom in choosing designs and materials. For information on a reference design, see the Bumper Guide under the Mechanical Resources section of the [Technical Resources page](#).

Figure 8-5 BUMPER Cross Section Example

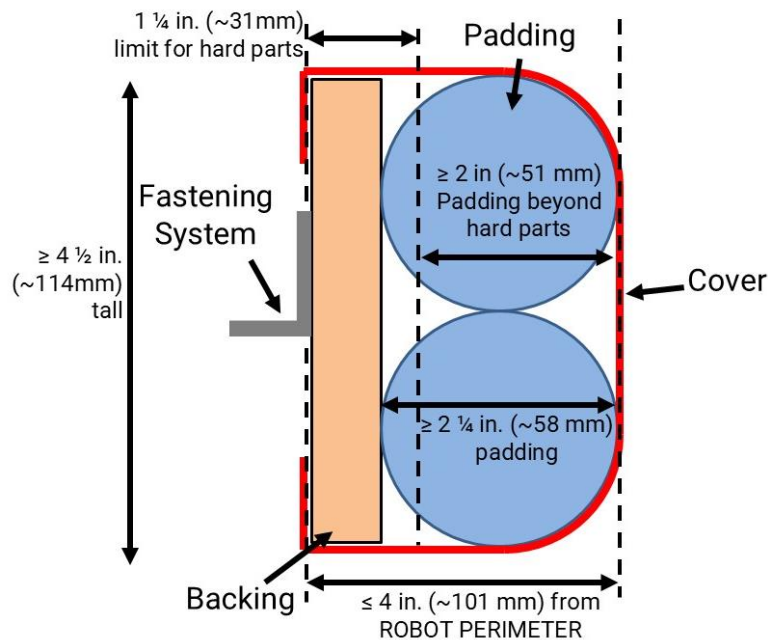

- R403** *BUMPER extension limit. BUMPERS must not extend more than 4 in. (~101 mm) from the ROBOT PERIMETER.
- R404** *BUMPERS must be soft. Hard parts of BUMPERS must not extend more than 1 1/4 in. (~31 mm) from the ROBOT PERIMETER. Padding must extend at least 2 in. (~51 mm) beyond any hard parts of the BUMPER.

Hard parts include any items which are likely to cause damage to the fabric or padding of other BUMPERS such as nuts and bolts, cable ties, hard plastics, etc.

- R405** *BUMPERS interact with BUMPERS. Padding (per R402-A) supported by backing (per R402-B) must entirely fill the BUMPER ZONE, a space between 2 1/2 in. (~63 mm) and 5 3/4 in. (~146 mm) from the floor.

Figure 8-6 BUMPER ZONE examples

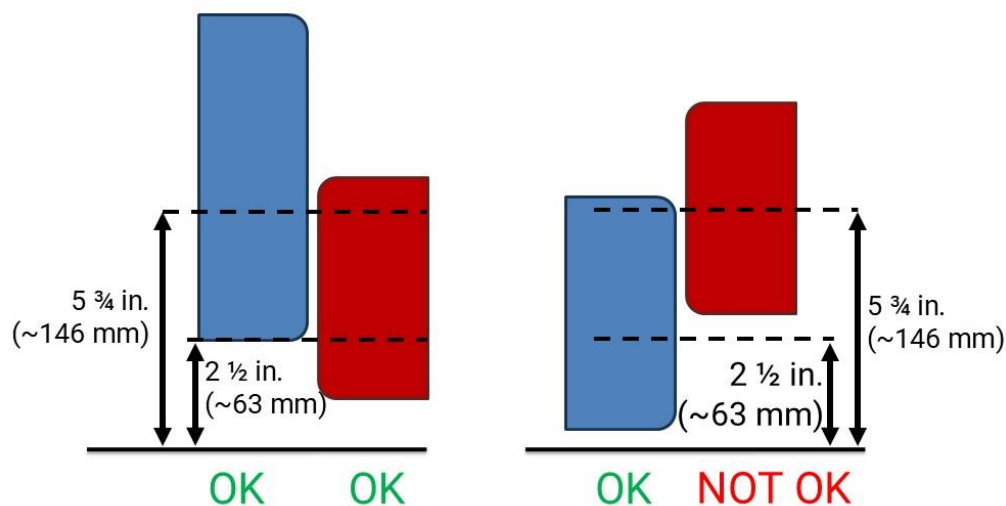

This measurement is intended to be made as if the ROBOT is resting on a flat floor (without changing the ROBOT configuration), not relative to the current height of the ROBOT from the FIELD carpet at any given time. Examples include:

Example 1: A ROBOT that is at an angle while navigating the FIELD has its BUMPERS outside the BUMPER ZONE. If this ROBOT were virtually transposed onto a flat floor, and its BUMPERS are in the BUMPER ZONE, it meets the requirements of this rule.

Example 2: A ROBOT deploys a MECHANISM which lifts the BUMPERS outside the BUMPER ZONE (when virtually transposed onto a flat floor). This violates this rule.

R406 *Fill BUMPER corners. Corner joints between BUMPERS must be filled with uncompressed padding material extending at least 2 ¼ in. (~58 mm) from the corner with no gaps or voids. Examples of implementation are shown in [Figure 8-7](#).

Figure 8-7 Uncompressed corner padding

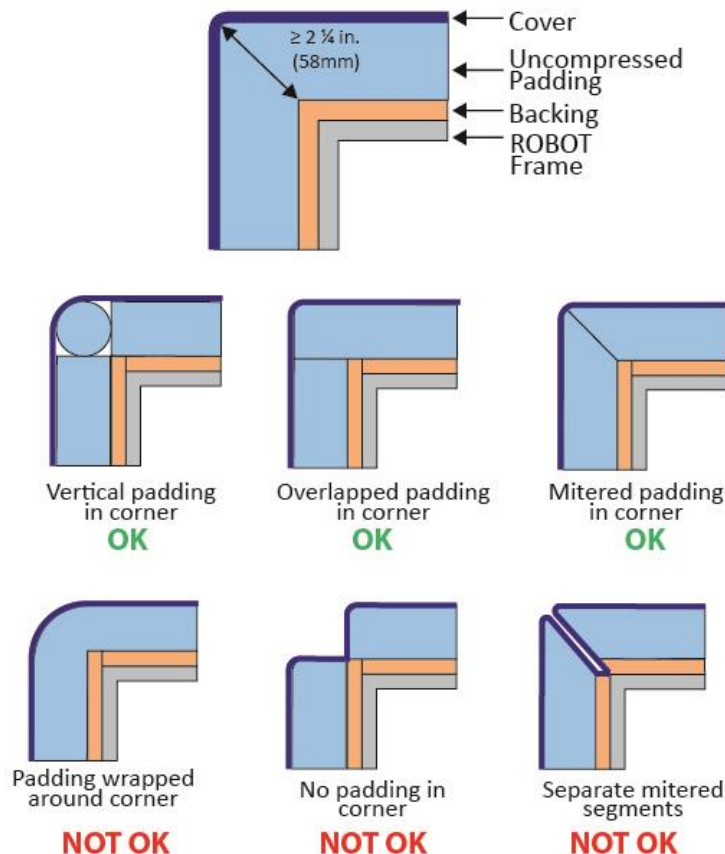

Examples that do not meet the requirements of R406:

- A. Foam cylinders or sheets bent around a sharp corner (less than 135°) are considered compressed.
- B. Separate bumper segments meeting at a miter in the corner are not considered to “fill” the corner due to the fabric covering.

R407 *BUMPERS shouldn't be wedges. BUMPERS must not act as wedges when interacting with other BUMPERS.

Examples of BUMPERS which act as a wedge include:

- A. BUMPERS utilizing softer foam towards the top of a BUMPER profile
- B. BUMPERS utilizing excessively rounded profiles such as a single semi-circle
- C. BUMPERS with significantly rounded profiles near the top of the BUMPER ZONE (e.g. placing the top of a foam cylinder such that it ends right at or just above the BUMPER ZONE)
- D. BUMPERS with tapered or stepped padding such that the padding is thinner or thicker towards the top or bottom

R408 *Weight limit with BUMPERS. The total weight of the ROBOT (as described in [R103](#)) with BUMPERS must not exceed 135 lbs. (~61 kg)

R409 *BUMPERS shouldn't move. BUMPERS must not be articulated, relative to the ROBOT PERIMETER.

R410 *BUMPERS must come off. BUMPERS must be designed for installation and removal to facilitate inspection and weighing.

As a guideline, BUMPERS should be able to be installed or removed by 2 people in fewer than 5 minutes.

R411 *BUMPERS indicate your ALLIANCE. Each ROBOT must be able to display red or blue BUMPERS to reflect their ALLIANCE color, as assigned in the MATCH schedule distributed at the event (as described in section [10.1 MATCH Schedules](#)). Contrasting markings on outward facing surfaces of the BUMPER, other than the following, are prohibited:

- A. those required per [R412](#),
- B. hook-and-loop tape, snap fasteners, or functional equivalents backed by the hard parts of the BUMPER,
- C. solid white *FIRST* logos between 4¾ in. (~121 mm) and 5¼ in. wide (~133 mm) (i.e. comparable to those available in the REEFSCAPE Virtual Kit), and
- D. narrow areas of underlying fabric exposed at seams, corners, or folds.

R412 *Team number on BUMPERS. Team numbers must be displayed and positioned on the BUMPERS such that an observer walking around the perimeter of the ROBOT can unambiguously tell the team's number from any point of view, from as far as approximately 60 ft. (1 829 cm), and meet the following additional criteria:

- A. consist of only white Arabic numerals at least 3 ¾ in. (~96 mm) high, at least ½ in. (~13 mm) in stroke width,

The ½ in. (~13 mm) stroke width requirement applies to the majority of the stroke. Font elements less than ½ in. (~13 mm) such as serifs, rounded edges, small hairlines or gaps, etc. are permitted as long as the majority of the stroke meets the sizing requirement and the numbers are unambiguous.

- B. must not wrap around sharp corners (less than 135°) of the ROBOT PERIMETER,
- C. must not split individual digits such that the team number is ambiguous, and

As a guideline, spacing between digits or groups of digits which exceeds ~4 in. (~101 mm) may be ambiguous.

D. may not substitute logos or icons for numerals.

There is no prohibition against splitting team numbers onto different sections of BUMPER. The intent is that the team's number is clearly visible and unambiguous so that Judges, REFEREES, Announcers, and other teams can easily identify competing ROBOTS.

This marking is intended to display the team number only, not to intentionally change the surface characteristics of the BUMPER. Excessive material usage as part of any team number marking will invite close scrutiny.

8.5 Motors & Actuators

R501 *Allowable motors. The only motors and actuators permitted include the following (in any quantity):

Table 8-1 Motor allowances

Motor Name	Part Numbers Available	
AndyMark 9015	am-0912	AndyMark 9015
AndyMark NeveRest	am-3104	
AndyMark PG	am-2161 (alt. PN am-2765)	am-2194 (alt. PN am-2766)
AndyMark RedLine Motor	am-3775	am-3775a
AndyMark Snow Blower Motor	am-2235	am-2235a
Banebots	am-3830	M5 – RS550-12
	M7-RS775-18	RS550VC-7527
	RS775WC-8514	RS550
CIM	FR801-001	PM25R-45F-1004
	M4-R0062-12	PM25R-45F-1003
	AM802-001A	PMR25R-45F-1003
	217-2000	PMR25R-44F-1005
	PM25R-44F-1005	am-0255
CTR Electronics Minion	24-777378	WCP-1691
CTR Electronics/VEX Robotics Falcon 500	217-6515	19-708850
	am-6515	am-6515_Short
Current/former KOP automotive motors	Denso AE235100-0160	Denso 262100-3040
	Denso 5-163800-RC1	Bosch 6 004 RA3 194-06
	Denso 262100-3030	Johnson Electric JE-PLG-149
		Johnson Electric JE-PLG-410
Nidec Dynamo BLDC Motor	am-3740	DM3012-1063

Motor Name	Part Numbers Available	
Playing with Fusion Venom	BDC-10001	
REV Robotics HD Hex	REV-41-1291	
REV Robotics NEO Brushless	REV-21-1650 (v1.0 or v1.1)	am-4258 am-4258a
REV Robotics NEO 550	REV-21-1651	am-4259
REV Robotics NEO Vortex	REV-21-1652	am-5275
VEX BAG	217-3351	
VEX Mini-CIM	217-3371	
West Coast Products Kraken x44	WCP-0941	
West Coast Products Kraken x60	WCP-0940	am-5274
West Coast Products RS775 Pro	217-4347	
Fans, no greater than 120mm (nominal) size and rated electrical input power no greater than 10 watts (W) continuous duty at 12 volts (VDC)		
Hard drive motors part of a legal COTS computing device		
Factory installed vibration and autofocus motors resident in COTS computing devices (e.g. rumble motor in a smartphone).		
PWM COTS rotational servos with stall current $\leq 4A$ and mechanical output power $\leq 8W$ at 6V. PWM COTS linear servos with max stall current $\leq 1A$ at 6V.		
Motors integral to a COTS sensor (e.g. LIDAR, scanning sonar, etc.), provided the device is not modified except to facilitate mounting		
1 compressor compliant with R806 and used to compress air for the ROBOT'S pneumatic system		
COTS linear actuators, electrical solenoid actuators, or electromagnets rated for 12V and wired downstream of a breaker 20A or less. Electrical solenoid actuators or electromagnets used at 24V must be rated for 24V.		

For servos, note that the roboRIO is limited to a max current output of 2.2A on the 6V rail (12.4W of electrical input power). Teams should make sure that their total servo power usage remains below this limit at all times.

Servo mechanical output power is approximated by the following formula (using 6V data reported by manufacturer): Mechanical Output Power (in W) = 0.25 x (Stall Torque in N-m) x (No Load Speed in rad/s). [This calculator from the FIRST Tech Challenge documentation](#) can be used to help calculate output power from inputs of various units.

Given the extensive amount of motors allowed on the ROBOT, teams are encouraged to consider the total power available from the ROBOT battery during the design and build of the ROBOT. Drawing large amounts of current from many motors at the same time could lead to drops in ROBOT battery voltage that may result in tripping the main breaker or trigger the brownout protection of the roboRIO. For more information about the roboRIO brownout protection and measuring current draw using the PDP/PDH, see [roboRIO Brownout and Understanding Current Draw](#).

AndyMark PG Gearmotors are sold with labeling based on the entire assembly. Assemblies labeled am-3651 through am-3656 contain legal motors specified in [Table 8-1](#). These motors may be used with or without the provided gearbox.

- R502 *Only 4 propulsion motors.** A ROBOT may not have more than 4 propulsion motors. A propulsion motor is a motor that enables the ROBOT to move around the FIELD surface. Motors that generate small amounts of thrust as a secondary or incidental feature are not considered propulsion motors.

Examples that are not considered propulsion motors include:

- A. motors that primarily alter the alignment of a wheel in contact with the FIELD surface (such as a swerve steering motor),
- B. motors that run MECHANISM wheels (e.g. for CORAL manipulation) that occasionally happen to contact the carpet, but without enough force to generate significant thrust, and
- C. motors that change the speed of the drive wheels using a shifting MECHANISM without significantly contributing to propulsion.

- R503 *Don't modify motors (mostly).** The integral mechanical and electrical system of any motor must not be modified. Motors, servos, and electric solenoids used on the ROBOT shall not be modified in any way, except as follows:

- A. The mounting brackets and/or output shaft/interface may be modified to facilitate the physical connection of the motor to the ROBOT and actuated part.
- B. The electrical leads may be trimmed to length as necessary and connectors or splices to additional wiring may be added.
- C. The locking pins on the window motors (P/N 262100-3030 and 262100-3040) may be removed.
- D. The connector housings on KOP automotive motors listed in [Table 8-1](#) may be modified to facilitate lead connections.
- E. Servos may be modified as specified by the manufacturer (e.g. re-programming or modification for continuous rotation).
- F. The wiring harness of the Nidec Dynamo BLDC Motor may be modified as documented by *FIRST* in [Nidec Dynamo BLDC Motor with Controller](#).
- G. Minimal labeling may be applied to indicate device purpose, connectivity, functional performance, etc.
- H. Any number of #10-32 plug screws may be removed from the Falcon 500 and the Kraken X60.
- I. Insulation may be applied to electrical terminals.
- J. Repairs, provided the original performance and specifications are unchanged.
- K. Maintenance recommended by the manufacturer.

The intent of this rule is to allow teams to modify mounting tabs and the like, not to gain a weight reduction by potentially compromising the structural integrity of any motor.

R504 *Power (most) actuators off of approved devices. With the exception of servos, fans, or motors integral to sensors of COTS computing devices permitted in [R501](#), each actuator must be controlled by a power regulating device. The only power regulating devices for actuators permitted on the ROBOT include:

- A. motor controllers:
 - a. DMC 60/DMC 60c Motor Controller (P/N 410-334-1, 410-334-2),
 - b. Jaguar Motor Controller (P/N MDL-BDC, MDL-BDC24, and 217-3367) connected to PWM only,
 - c. Koors40 Motor Controller (P/N am-5600),
 - d. Nidec Dynamo, BLDC Motor with Controller to control integral actuator only (P/N 840205-000, am-3740)
 - e. SD540 Motor Controller (P/N SD540x1, SD540x2, SD540x4, SD540Bx1, SD540Bx2, SD540Bx4, SD540C),
 - f. Spark Flex Motor Controller (P/N REV-11-2159, am-5276)
 - g. Spark Motor Controller (P/N REV-11-1200, am-4260),
 - h. Spark MAX Motor Controller (P/N REV-11-2158, am-4261),
 - i. Talon FX Motor Controller (P/N 217-6515, 19-708850, am-6515, am-6515_Short, WCP-0940, WCP-0941) for controlling integral Falcon 500, Kraken X60, Kraken X44 only,
 - j. Talon FXS Motor Controller (P/N 24-708883, WCP-1692)
 - k. Talon Motor Controller (P/N CTRE_Talon, CTRE_Talon_SR, and am-2195),
 - l. Talon SRX Motor Controller (P/N 217-8080, am-2854, 14-838288),
 - m. Thrifty Nova (P/N TTB-0100),
 - n. Venom Motor with Controller (P/N BDC-10001) for controlling integral motor only,
 - o. Victor 884 Motor Controller (P/N VICTOR-884-12/12),
 - p. Victor 888 Motor Controller (P/N 217-2769),
 - q. Victor SP Motor Controller (P/N 217-9090, am-2855, 14-868380), and
 - r. Victor SPX Motor Controller (P/N 217-9191, 17-868388, am-3748).
- B. relay modules:
 - a. Spike H-Bridge Relay (P/N 217-0220 and SPIKE-RELAY-H),
 - b. Automation Direct Relay (P/N AD-SSR6M12-DC-200D, AD-SSRM6M25-DC-200D, AD-SSR6M40-DC-200D), and
 - c. Power Distribution Hub (PDH) switched channel (P/N REV-11-1850) for controlling non-actuator CUSTOM CIRCUITS only.
- C. pneumatics controllers:
 - a. Pneumatics Control Module (P/N am-2858, 217-4243) and
 - b. Pneumatic Hub (P/N REV-11-1852).
- D. servo controllers:
 - a. Servo Hub (P/N REV-11-1855)

Note: The Automation Direct Relays are single directional. Per [R504](#) they may not be wired together in an attempt to provide bi-directional control.

R505 *Don't overload controllers. Each power regulating device may control electrical loads per [Table 8-2](#). Unless otherwise noted, each power regulating device shall control 1 and only 1 electrical load.

Table 8-2 Power regulating device allotments

Electrical Load	Motor Controller	Relay Module	Pneumatics Controller
AndyMark RedLine Motor Banebots CIM CTR Electronics Minion REV Robotics NEO Brushless REV Robotics NEO 550 REV Robotics NEO Vortex VEX Mini-CIM WCP RS775 Pro	Yes	No	No
AndyMark 9015 VEXpro BAG	Yes (up to 2 per controller)	No	No
AndyMark PG KOP Automotive Motors NeveRest Snow Blower Motor REV Robotics HD Hex	Yes (up to 2 per controller)	Yes	No
Linear Actuator	Yes (20A breaker max)	Yes (20A breaker max)	No
CTR Electronics/VEX Falcon 500 Nidec Dynamo BLDC Motor w/ Controller Playing With Fusion Venom WCP Kraken X44 WCP Kraken X60	Yes (integrated controller only)	No	No
Compressor	No	Yes	Yes
Pneumatic Solenoid Valves	No	Yes (multiple)	Yes (1 per channel)
Electric Solenoids	Yes (multiple)	Yes (multiple)	Yes (1 per channel)
CUSTOM CIRCUITS	Yes (multiple)	Yes (multiple)	Yes (multiple)

R506 *Control servos safely. Servos must be connected to, and only to, 1 of the following:

- A. PWM ports on the roboRIO,
- B. PWM ports on a WCP Spartan Sensor Board (P/N WCP-0045),
- C. REV Robotics Servo Power Module (P/N REV-11-1144),
- D. REV Robotics Servo Hub (P/N REV-11-1855)

8.6 Power Distribution

In order to maintain safety, the rules in this section apply at all times while at the event, not just while the ROBOT is on the FIELD for MATCHES.

R601 *Battery limit – everyone has the same power. The only legal source of electrical energy for the ROBOT during the competition, the ROBOT battery, must be 1 and only 1 non-spillable sealed lead acid (SLA) battery with the following specifications:

- A. Nominal voltage: 12V
- B. Nominal capacity at 20-hour discharge rate: minimum 17Ah, maximum 18.2Ah
- C. Shape: Rectangular
- D. Nominal Dimensions: 7.1 in. x 3 in. x 6.6 in., +/- .1 in. for each dimension (~ 180 mm x 76mm x 168 mm, +/- 2.5 mm for each dimension)
- E. Nominal weight: 11lbs. to 14.5 lbs. (~5 kg. to 6.5 kg.)
- F. Terminals: Nut and bolt style

"Nut and bolt style" refers to any style battery terminal where the connector is secured to the battery using a threaded fastener.

Examples of batteries which meet these criteria include:

- A. Energys (P/N NP18-12, NP18-12B, NP18-12BFR),
- B. MK Battery (P/N ES17-12),
- C. Battery Mart (P/N SLA-12V18),
- D. Sigma (P/N SP12-18),
- E. Universal Battery (P/N UB12180),
- F. Power Patrol (P/N SLA1116),
- G. Werker Battery (P/N WKA12-18NB),
- H. Power Sonic (P/N PS-12180NB),
- I. Yuasa (P/N NP18-12B),
- J. Panasonic (P/N LC-RD-1217),
- K. Interstate Batteries (P/N BSL1116), and
- L. Duracell Ultra Battery (P/N DURA12-18NB).

Teams should be aware that they may be asked to provide documentation of the specifications of any battery not listed above.

Batteries should be charged in accordance with manufacturer's specification. (Please see the [FIRST Safety Manual](#) for additional information.)

R602 *Other batteries for cameras or computers only. COTS USB battery packs with a capacity of 100Wh or less (27000mAh at 3.7V) with 5V/5A max output or 12V/5A max output using USB-PD per port, batteries integral to and part of a COTS computing device or self-contained camera (e.g. laptop batteries, GoPro style camera, etc.), or batteries used to power CMOS/RTC features may be used to power COTS computing devices and any peripheral COTS input or output devices connected to the COTS computing device provided they are:

- A. securely fastened to the ROBOT,
- B. connected only using unmodified COTS cables, and
- C. charged according to manufacturer recommendations.

A COTS computing device is a non-roboRIO device used to process or collect sensor information (e.g. a "smart flashlight" is not a COTS computing device).

- R603** ***Charge batteries with safe connectors.** Any battery charger used to charge a ROBOT battery must have the corresponding Anderson SB connector installed.
- R604** ***Charge batteries at a safe rate.** Any battery charger used to charge a ROBOT battery may not be used such that it exceeds 6-Amp average charge current.
- R605** ***Batteries are not ballast.** No batteries other than those allowed per [R601](#) and [R602](#) are allowed on the ROBOT, whether or not they are being used to supply power.

For example, teams may not use additional batteries as extra weight on their ROBOTS.

- R606** ***Secure the battery.** The ROBOT battery must be secured such that it will not dislodge during vigorous ROBOT interaction including if the ROBOT is turned over or placed in any arbitrary orientation.
- R607** ***Insulate battery connections.** Each electrical terminal on the ROBOT battery, main breaker, and their connections (lugs, stripped wire ends, etc.) to the wire must be fully insulated at all times.
- R608** ***Limit non-battery energy.** Non-electrical sources of energy used by the ROBOT (i.e., stored at the start of a MATCH) shall come only from the following sources:
- A. compressed air stored in the pneumatic system that has been charged in compliance with R806 and R807,
 - B. a change in the altitude of the ROBOT center of gravity,
 - C. storage achieved by deformation of ROBOT parts,
 - D. closed-loop COTS pneumatic (gas) shocks, or
 - E. air-filled (pneumatic) wheels.
- R609** ***Connect main power safely.** The following devices shall be connected with 6 AWG (7 SWG or 16 mm²) copper wire or larger as shown in [Figure 8-9](#):
- A. 1 ROBOT battery,
 - B. a single pair of Anderson Power Products (or APP) 2-pole SB type connectors,
 - C. the 1 main 120-Amp (120A) surface mount circuit breaker (Cooper Bussman P/N CB185-120, CB185F-120, CB285-120 CB285F-120, CB285120F or Optifuse P/N 153120, 253120), and
 - D. the 1 power distribution device (CTR Electronics Power Distribution Panel, PDP or PDP 2.0, P/N am-2856, 217-4244, 14-806880, 24-806880 or REV Robotics Power Distribution Hub, PDH, P/N REV-11-1850)

No additional devices or modifications shall be permitted with the following exceptions:

- E. Monitoring circuitry permitted by [R625](#)
- F. SB-50 to SB-120 adapters, provided they have been presented for Inspection.

Figure 8-8 Electrical connection diagram

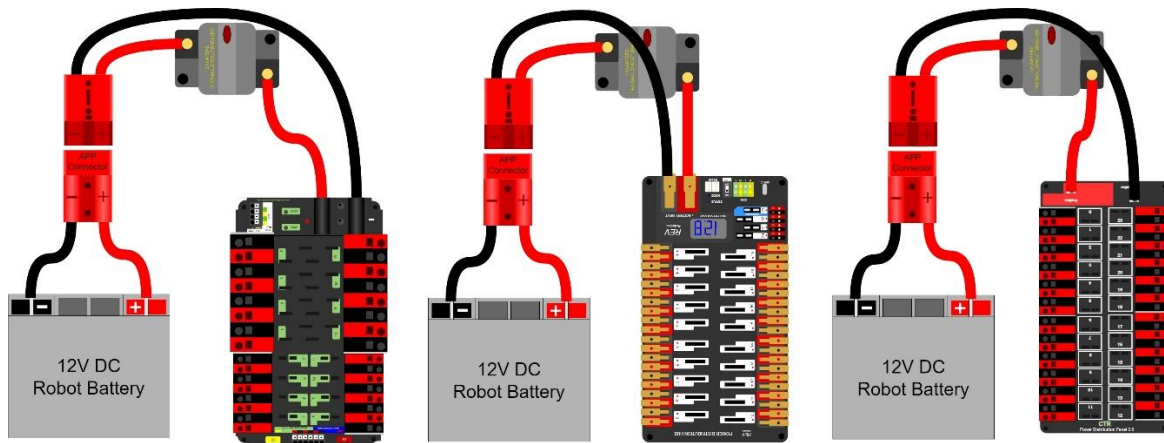

“SB type” refers to SB type only (e.g. SB-50, SB-120, etc.), not SBS or any other part type beginning with SB. All batteries supplied by *FIRST* (such as Spare Parts and international batteries) will have a red or pink SB50 connector installed which may not be removed.

The pink connectors included in the KOP mate with the red SB50 connector.

- R610** *1 breaker per circuit. All circuits, with the exceptions of those listed in [R615](#) and [R617](#), must connect to, and have power sourced solely by, a single protected 12VDC WAGO connector pair (i.e. the load terminals, as shown in [Figure 8-9](#)) of the PDP/PDP2.0/PDH, not the M6 cap screws.
- R611** *The ROBOT frame is not a wire. All wiring and electrical devices shall be electrically isolated from the ROBOT frame. The ROBOT frame must not be used to carry electrical current.

Compliance with this rule is checked by observing a $>120\Omega$ resistance between either the (+) or (-) post within the APP connector that is attached to the PDP/PDP2.0/PDH and any point on the ROBOT.

All legal motor controllers with metal cases are electrically isolated. They may be mounted directly to ROBOT frame COMPONENTS.

Note that some cameras, decorative lights, and sensors (e.g. some encoders, some IR sensors, etc.) have grounded enclosures or are manufactured with conductive plastics. These devices must be electrically isolated from the ROBOT frame to ensure compliance with this rule.

- R612** *Must be able to turn ROBOT on and off safely. The 120A circuit breaker must be quickly and safely accessible from the exterior of the ROBOT. This is the only 120A circuit breaker allowed on the ROBOT.

Examples considered not “quickly and safely accessible” include breakers covered by an access panel or door, or mounted on, underneath or immediately adjacent to moving COMPONENTS.

It is strongly recommended that the 120A circuit breaker location be clearly and obviously labeled so it can be easily found by FIELD STAFF if needed.

While the main breaker must be accessible, consider positioning or shielding it such that it’s protected from accidental actuation (e.g. it’s unlikely to be hit by a SCORING ELEMENT during game play).

R613 *Electrical system must be inspectable. The PDP/PDP2.0/PDH, associated wiring, and all circuit breakers must be visible for inspection.

“Visible for inspection” does not require that the items be visible when the ROBOT is in STARTING CONFIGURATION, provided the team can make the items viewable during the inspection process.

R614 *No high voltage allowed. Any active electrical item that is not an actuator (specified in [R501](#)) or core control system item (specified in [R710](#)) is considered a CUSTOM CIRCUIT. CUSTOM CIRCUITS shall not produce measurable voltages exceeding 24V with the exception of COTS Power-over-Ethernet (PoE) injector devices used with COTS Ethernet cables and COTS receiving devices (i.e. not a breakout or adapter).

R615 *Power roboRIO as specified. The roboRIO power input must be connected to either:

- A. the dedicated supply terminals on the PDP shown in [Figure 8-9](#) or

Figure 8-9 roboRIO power source on a PDP

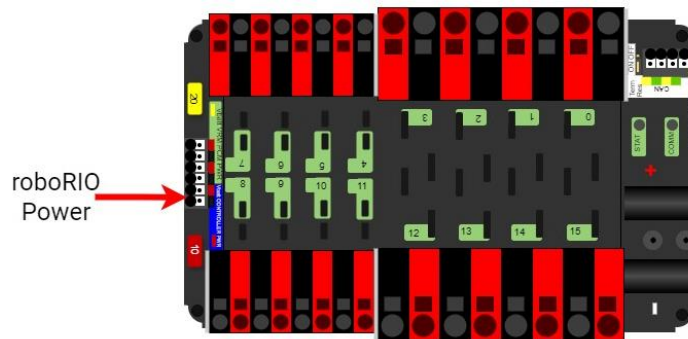

- B. the terminals of 1 of the non-switchable fused channels on the PDH (20,21,22) with a 10A fuse or circuit breaker installed in the associated fuse holder, or

Figure 8-10 roboRIO power source on a PDH

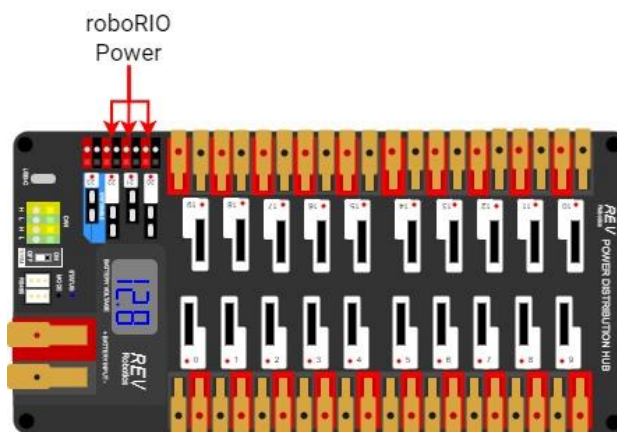

- C. directly to the terminals of any single channel on the PDP 2.0 with a 10A fuse or circuit breaker installed in the associated fuse holder.

Figure 8-11 roboRIO power source on a PDP 2.0

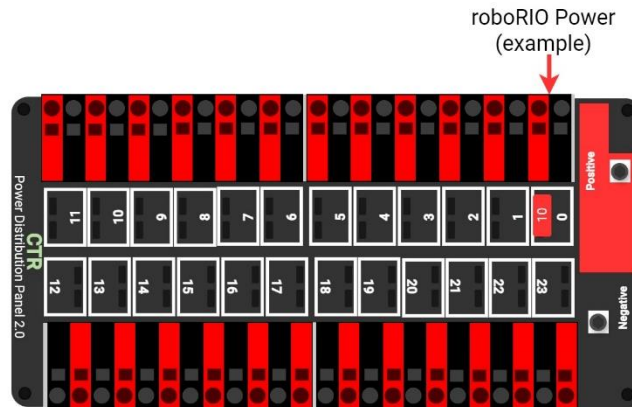

- R616 *Power radio as specified – Part 1.** The wireless bridge (radio) power must be supplied by either:
- the 12V 2A output of a CTR Electronics Voltage Regulator Module (VRM) (P/N am-2857, 217-4245), as shown in [Figure 8-12](#), and must be the only load connected to those terminals or

Figure 8-12 Radio power source from a VRM

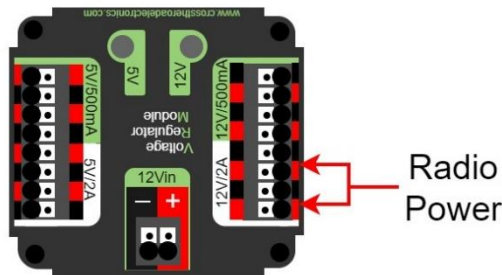

- using an Ethernet cable between a REV Radio Power Module (RPM) (P/N REV-11-1856) and the “RIO” Ethernet port on the wireless bridge (or the 18-24v POE port for events using OM5P radios), or
- directly from the PDP/PDP2.0/PDH ports described in [R617](#) (this option is not permitted for OM5P radios)

Note that this prohibits using any other active POE injector device to power the radio but does not prohibit using any PASSIVE CONDUCTORS to inject the VRM or direct PDP/PDP2.0/PDH power into an Ethernet cable plugged into the radio port labeled “RIO.”

The use of a VRM or RPM to power the VH-109 radio is permitted in 2025 to allow transition to the new radio. In 2026 the radio will be required to be wired directly to the PDP/PDP2.0/PDH.

- R617 *Power radio as specified – Part 2.** The device supplying power to the wireless bridge per [R616](#) must be connected to either:
- the designated supply terminals at the end of the PDP, as shown in [Figure 8-13](#). With the exception of a single CTR Electronics Pneumatics Control Module (PCM, P/N am-2858) or REV Robotics Pneumatic Hub (PH, P/N REV-11-1852), no other electrical load shall be connected to these PDP terminals,

Figure 8-13 VRM, PCM, RPM, and Radio power source on a PDP

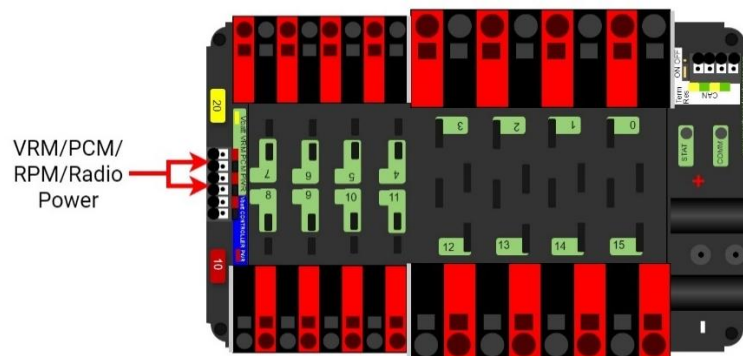

- B. the terminals of the non-switchable fused channels on the PDH (20,21,22) with a 10A fuse or circuit breaker installed in the associated fuse holder. No other electrical load shall be connected to that channel, or

Figure 8-14 VRM/RPM/Radio power source on a PDH

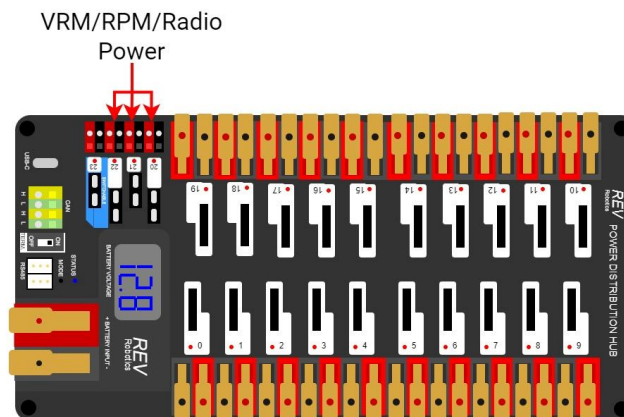

- C. directly to the terminals of any channel on the PDP 2.0 with a 10A fuse or circuit breaker installed in the associated fuse holder.

Figure 8-15 VRM/RPM/Radio power source on a PDP 2.0

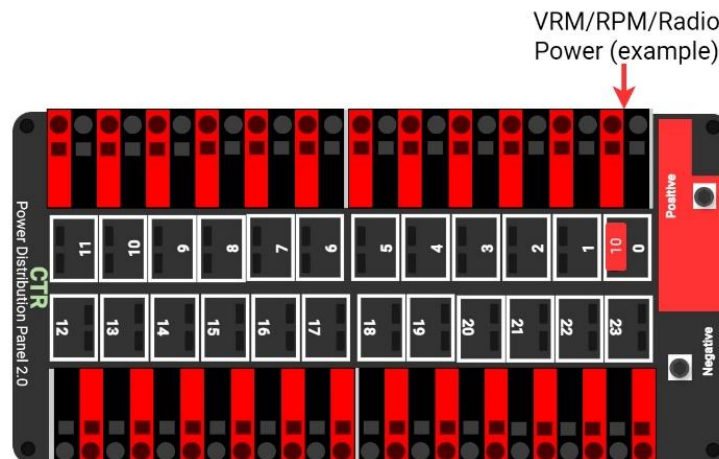

Please reference [How to Wire an FRC Robot](#) for wireless bridge wiring information.

R618 *Use **PDP/PDP2.0/PDH terminals as designed**. Only 1 wire shall be connected to each terminal on the PDP/PDP2.0/PDH.

If multi-point distribution of circuit power is needed (e.g. to provide power to multiple PCMs and/or VRMs from 1 20A circuit), then all incoming wires may be appropriately spliced into the main lead (e.g. using an insulated terminal block, crimped splice or soldered wire splice), and the single main lead inserted into the terminal to power the circuit.

R619 *Only use specified circuit breakers in PDP/PDP2.0/PDH. The only circuit breakers permitted for use in the PDP/PDP2.0/PDH are:

- A. Snap Action VB3-A Series or AT2-A, terminal style F57, 40A rating or lower,
- B. Snap Action MX5-A or MX5-L Series, 40A rating or lower,
- C. REV Robotics ATO auto-resetting breakers 40A rating or lower,
- D. Any ATM circuit breaker with value less than or equal to the fuses permitted per [R620](#).

R620 *Only use specified fuses in PDP/PDP2.0/PDH. The only fuses permitted for use in the PDP/PDP2.0/PDH are mini automotive blade fuses with the following values:

- A. for the PDP, ATM style fuses with values matching the value printed on the device's corresponding fuse holder,
- B. for the PDP 2.0, ATC/ATO style fuses with values 10A or lower, and
- C. for the PDH, ATM style fuses with values 15A or lower with the exception of a single 20A fuse for powering a PCM or PH.

Note that these fuses must be pressed very firmly to seat properly. Improper seating can cause a device to reboot upon impact.

R621 *Protect circuits with appropriate circuit breakers. Each branch circuit must be protected by 1 and only 1 circuit breaker or fuse on the PDP/PDP2.0/PDH per [Table 8-3](#). No other electrical load can be connected to the breaker or fuse supplying this circuit with the exception of devices downstream of a Kraken X60 Powerpole adapter board (WCP-1380, RF-4003).

Table 8-3 Branch circuit protection requirements

Branch Circuit	Circuit Breaker/Fuse Value	Quantity Allowed Per Breaker
Motor Controller	Up to 40A	1
CUSTOM CIRCUIT	Up to 40A	No limit
Automation Direct Relay 40A (*6M40*)	Up to 40A	1
Fans permitted per R501 and not already part of COTS computing devices.	Up to 20A	No limit
Spike Relay Module	Up to 20A	1

Branch Circuit	Circuit Breaker/Fuse Value	Quantity Allowed Per Breaker
Automation Direct Relay 25A (*6M25*)	Up to 20A	1
PCM/PH – with compressor	Up to 20A	1
Servo Power Module/Servo Hub	Up to 20A	1
Additional VRM (non-radio)/Additional PCM/PH (non-compressor)	Up to 20A	3 total
Automation Direct Relay 12A (*6M12*)	Up to 10A	1

This rule does not prohibit the use of smaller value breakers in the PDP/PDP2.0/PDH or any fuses or breakers within CUSTOM CIRCUITS for additional protection.

Fans permitted per [R501](#) may also be included within CUSTOM CIRCUITS.

R622 *Use appropriately sized wire. All circuits shall be wired with appropriately sized insulated copper wire (SIGNAL LEVEL cables don't have to be copper):

Table 8-4 Breaker and wire sizing

Application	Minimum Wire Size
31 – 40A breaker protected circuit	12 AWG (13 SWG or 4 mm ²)
21 – 30A breaker protected circuit	14 AWG (16 SWG or 2.5 mm ²)
6 – 20A breaker protected circuit	18 AWG (19 SWG or 1 mm ²)
11-20A fuse protected circuit	
Between the PDP dedicated terminals and the VRM/RPM or PCM/PH	
Compressor outputs from the PCM/PH	
Between the PDH and PCM/PH	22 AWG (22 SWG or 0.5 mm ²)
Between the PDP/PDP2.0/PDH and the roboRIO	
Between the PDH and VRM/RPM	
Kraken x60 Powerpole Adapter protected circuit	
≤5A breaker protected circuit	
≤10A fuse protected circuit	

Application	Minimum Wire Size
VRM 2A circuits	24 AWG (24 SWG or .25 mm ²)
roboRIO PWM port outputs	26 AWG (27 SWG or 0.14 mm ²)
SIGNAL LEVEL circuits (i.e. circuits which draw $\leq 1A$ continuous and have a source incapable of delivering $>1A$, including but not limited to roboRIO non-PWM outputs, CAN signals, PCM/PH Solenoid outputs, VRM 500mA outputs, RPM outputs, and Arduino outputs)	28 AWG (29 SWG or .08 mm ²)

Wires that are recommended by the device manufacturer or originally attached to legal devices are considered part of the device and by default legal. Such wires are exempt from this rule, provided they are powered by the smallest value fuse or breaker which permits proper device operation.

In order to show compliance with these rules, teams should use wire with clearly labeled sizes if possible. If unlabeled wiring is used, teams should be prepared to demonstrate that the wire used meets the requirements of this rule (e.g. wire samples and evidence that they are the required size).

R623 ***Use only appropriate connectors.** Branch circuits may include intermediate elements such as COTS connectors, splices, COTS flexible/rolling/sliding contacts, and COTS slip rings, as long as the entire electrical pathway is via appropriately gauged/rated elements.

Slip rings containing mercury are prohibited per [R203](#).

R624 ***Use specified wire colors (mostly).** All non-SIGNAL LEVEL wiring with a constant polarity (i.e., except for outputs of relay modules, motor controllers, or sensors) shall be color-coded along their entire length from the manufacturer as follows:

- A. red, yellow, white, brown, or black-with-stripe on the positive (e.g. +24VDC, +12VDC, +5VDC, etc.) connections
- B. black or blue for the common or negative side (-) of the connections

Exceptions to this rule include:

- C. wires that are originally attached to legal devices and any extensions to these wires using the same color as the manufacturer
- D. Ethernet cable used in POE cables

R625 ***Don't modify critical power paths.** CUSTOM CIRCUITS shall not directly alter the power pathways between the ROBOT battery, PDP/PDP2.0/PDH, motor controllers, relays (per [R504-B](#)), motors and actuators (per [R501](#)), pneumatic solenoid valves, or other elements of the ROBOT control system (items explicitly mentioned in [R710](#)). Custom high impedance voltage monitoring or low impedance current monitoring circuitry connected to the ROBOT'S electrical system is acceptable, if the effect on the ROBOT outputs is inconsequential.

A noise filter may be wired across motor leads or PWM leads. Such filters will not be considered CUSTOM CIRCUITS and violate neither this rule nor [R712](#).

Acceptable signal filters must be fully insulated and must be 1 of the following:

- 1 microfarad (1 μ F) or less, non-polarized, capacitor may be applied across the power leads of any motor on your ROBOT (as close to the actual motor leads as reasonably possible) or
- a resistor may be used as a shunt load for the PWM control signal feeding a servo.

8.7 Control, Command & Signals System

R701 *Control the ROBOT with a roboRIO. ROBOTS must be controlled via 1 programmable NI roboRIO or roboRIO 2.0 (P/N am3000 or am3000a, both versions referred to throughout this manual as “roboRIO”), with image version 2025_v2.0 or later.

There are no rules that prohibit co-processors, provided commands originate from the roboRIO to enable and disable all power regulating devices. This includes motor controllers legally wired to the CAN bus.

R702 *Communicate with the ROBOT with the specified radio. 1 Vivid Hosting wireless bridge (P/N: VH-109), that has been configured with the appropriate encryption key for your team number at each event, is the only permitted device for communicating to and from the ROBOT during the MATCH. Events held in China and Chinese Taipei are the exceptions to this rule and must use an OpenMesh (P/N: OM5P-AN or OM5P-AC) radio.

R703 *Use specific Ethernet port for roboRIO. The roboRIO Ethernet port must be connected to the wireless bridge port labeled “RIO” for VH-109 radios or “18-24v POE” for OpenMesh radios (either directly, via a network switch, via an RPM, or via a CAT5 Ethernet pigtail).

Note: Placing a switch between the roboRIO and radio may impede the ability for FIELD STAFF to troubleshoot roboRIO connection issues on the FIELD. Teams may be asked to connect directly between the radio and the roboRIO as part of troubleshooting efforts.

R704 *Only use allowed ports and bandwidth to communicate with the ROBOT. Communication between the ROBOT and the OPERATOR CONSOLE may not exceed the following and is restricted to network ports listed in [Table 8-5](#):

- A. 7 Mbits/second for Vivid Hosting wireless bridge radios
- B. 4 Mbits/second for OpenMesh radios

Table 8-5 Open FMS ports

Port	Designation	Bi-directional?
UDP/TCP 1180-1190	Camera data from the roboRIO to dashboard software when the camera is connected the roboRIO via USB	Yes
TCP 1735	SmartDashboard	Yes
UDP 1130	Dashboard-to-ROBOT control data	Yes
UDP 1140	ROBOT-to-Dashboard status data	Yes

Port	Designation	Bi-directional?
HTTP 80	Camera connected via switch on the ROBOT	Yes
HTTP 443	Camera connected via switch on the ROBOT	Yes
UDP/TCP 554	Real-Time Streaming Protocol for h.264 camera streaming	Yes
UDP/TCP 1250	CTRE Diagnostics Server	Yes
UDP/TCP 5800-5810	Team use	Yes

Teams may use these ports as they wish if they do not employ them as outlined above (i.e. TCP 1180 can be used to pass data back and forth between the ROBOT and the Driver Station Software if the team chooses not to use the camera on USB).

Note that the 4 Mbit limit will be strictly enforced by the wireless bridge.

The [FMS Whitepaper](#) has more details on how to check and optimize bandwidth usage.

While *FIRST* makes every effort to provide a wireless environment that allows teams access to a full 4 Mbits/second data rate (with about 100 Kbit used for ROBOT control and status), at some events wireless conditions may not accommodate this.

- R705** ***Configure devices for your team number.** The roboRIO, Driver Station Software, and wireless bridge must be configured to correspond to the correct team number, per the procedures defined in the [FIRST Robotics Competition Control System documentation](#).
- R706** ***Don't bypass the ARENA network.** All signals must originate from the OPERATOR CONSOLE and be transmitted to the ROBOT via the ARENA Ethernet network.
- R707** ***Limited wireless allowed.** The only forms of wireless communication that may be used to communicate to, from, or within the ROBOT, include:
- A. those required per [R702](#) and [R706](#)
 - B. tags used for location detection systems if provided by the event
 - C. RFID or NFC systems used exclusively within the ROBOT

Devices that employ signals in the visual spectrum (e.g. cameras) and non-RF sensors that don't receive human-originated commands (e.g. "beam break" sensors or IR sensors on the ROBOT used to detect FIELD elements) are not wireless communication devices and thus this rule doesn't apply.

- R708** ***Wireless bridge must be visible.** The wireless bridge must be mounted on the ROBOT such that the diagnostic lights are visible to FIELD STAFF.

Teams are encouraged to mount the wireless bridge away from noise generating devices such as motors, PCM(s)/PH(s), and VRM(s)/RPM(s).

- R709** ***ROBOTS must have a signal light.** ROBOTS must use at least 1, but no more than 2, diagnostic ROBOT Signal Light (RSL) (P/N 855PB-B12ME522 and/or am-3583).

Any RSL must be:

- A. mounted on the ROBOT such that it is easily visible while standing 3 ft. (~ 100 cm) away from at least one side of the ROBOT,
- B. connected to the "RSL" supply terminals on the roboRIO, and
- C. if using the 855PB-B12ME522, wired for solid light operation, by placing a jumper between the "La" and "Lb" terminals on the light per [Figure 8-16](#).

Please see [How to Wire an FRC ROBOT](#) for connection details.

Figure 8-16 855PB-B12ME522 jumper wiring

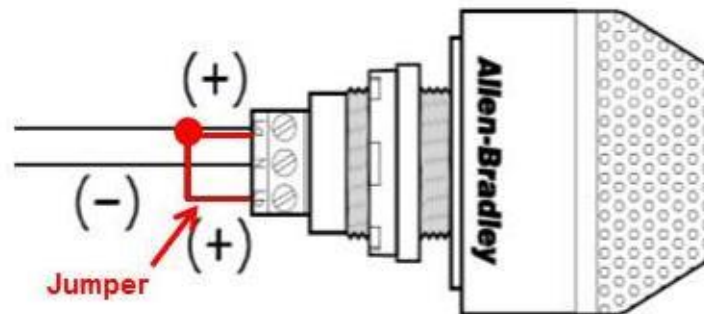

- R710** ***Only specified modifications to control system devices permitted.** The Driver Station Software, roboRIO, PDP/PDP2.0/PDH, PCM(s)/PH(s), VRM(s)/RPM(s), RSL, 120A breaker, motor controllers, MXP devices used to control actuators per [R713-C](#), relay modules (per [R504-B](#)), wireless bridge, PDP/PDP2.0/PDH breakers and fuses, Servo Power Module, and batteries shall not be tampered with, modified, or adjusted in any way (tampering includes drilling, cutting, machining, rewiring, disassembling, painting, etc.), with the following exceptions:

Please note that the Driver Station Software is a separate application from the Dashboard. The Driver Station Software may not be modified, while teams are expected to customize their Dashboard code.

- A. User programmable code in the roboRIO may be customized.
- B. Motor controllers may be calibrated as described in owner's manuals.
- C. Fans may be attached to motor controllers and may be powered from the power input terminals.
- D. If powering the compressor, the fuse on a Spike H-Bridge Relay may be replaced with a VB3A-20A Snap-Action circuit breaker.
- E. Wires, cables, and signal lines may be connected via the standard connection points provided on the devices.
- F. Fasteners (including adhesives) may be used to attach the device to the OPERATOR CONSOLE or ROBOT or to secure cables to the device.
- G. Thermal interface material may be used to improve heat conduction.
- H. Labeling may be applied to indicate device purpose, connectivity, functional performance, etc.
- I. Jumpers may be changed from their default location.
- J. Limit switch jumpers may be removed from a Jaguar motor controller and a custom limit switch circuit may be substituted.
- K. Device firmware may be updated with manufacturer supplied firmware.
- L. Integral wires on motor controllers may be cut, stripped, and/or connectorized.

- M. Devices may be repaired, provided the performance and specifications of the device after the repair are identical to those before the repair.
- N. The cover may be removed from the Talon SRX or Talon FX data port.
- O. Electrical tape may be applied to the aluminum plate inside the wireless bridge.
- P. The input terminal cover from the PDP may be omitted (no other element may be installed using the threaded holes to install something in place of the PDP terminal cover).
- Q. The roboRIO 2.0 SD card may be replaced with an SD card of any capacity.
- R. adding insulating material to exposed conductors.
- S. replacing control system power terminal blocks (e.g. RSL power connector) with functional equivalents
- T. tape may be applied for debris protection.

Please note that while repairs are permitted, the allowance is independent of any manufacturer's warranty. Teams make repairs at their own risk and should assume that any warranty or return options are forfeited. Be aware that diagnosing and repairing COMPONENTS such as these can be difficult.

For more information about modification O, please see [this OM5P-AC Radio Modification article](#).

- R711** ***Don't connect motor outputs to roboRIO.** Neither 12VDC power nor relay module or motor controller outputs shall be directly connected to the roboRIO, with the exception of the designated 12VDC input.
- R712** ***Control PWM controllers from the roboRIO.** Every relay module (per [R504-B](#)), servo controller, and PWM motor controller shall be connected to a corresponding port (relays to Relay ports, servo controllers and PWM controllers to PWM ports) on the roboRIO (either directly or through a WCP Spartan Sensor Board) or via a legal MXP connection (per [R713](#)). They shall not be controlled by signals from any other source, with the exception of the Nidec Dynamo motor controller which must also be connected to the roboRIO Digital I/O.
- R713** ***Only approved MXP devices can control actuators.** If a motor is controlled via the MXP, its power regulating device must be connected by 1 of the following methods:
- A. directly to any PWM pins,
 - B. via a network of PASSIVE CONDUCTORS used to extend the PWM pins, or
 - C. via 1 approved ACTIVE DEVICE:
 - a. Kauai Labs navX MXP
 - b. Kauai Labs navX2 MXP
 - c. RCAL MXP Daughterboard
 - d. REV Robotics RIOduino
 - e. REV Robotics Digit Board
 - f. West Coast Products Spartan Sensor Board
 - g. Huskie Robotics HUSKIE 2.0 Board

A PASSIVE CONDUCTOR is any device or circuit whose capability is limited to the conduction and/or static regulation of the electrical energy applied to it (e.g. wire, splices, connectors, printed wiring board, etc.).

An ACTIVE DEVICE is any device capable of dynamically controlling and/or converting a source of electrical energy by the application of external electrical stimulus.

The “network of PASSIVE CONDUCTORS” only applies to the pins being used for PWM output to motors or servos. This means that connecting an ACTIVE DEVICE, such as a sensor to 1 MXP pin does not prevent other MXP pins from being used in accordance with B.

- R714** *Control CAN motor controllers from the roboRIO. Each CAN motor controller must be controlled with enable/disable inputs sourced from the roboRIO and passed via either a PWM (wired per [R713](#)) or CAN bus (either directly or daisy-chained via another CAN bus device) signal, but both shall not be wired simultaneously on the same device.

As long as the CAN bus is wired legally so that the heartbeat from the roboRIO is maintained, all closed loop control features of the CAN motor controller may be used. (That is, commands originating from the roboRIO to configure, enable, and specify an operating point for all CAN motor controller closed loop modes fit the intent of [R701](#)).

“Wired directly” includes via any series of PASSIVE CONDUCTORS (i.e. star or hub configurations using only PASSIVE CONDUCTORS are permitted.)

- R715** *Control PCM/PH(S) from roboRIO. Each PCM/PH must be controlled with signal inputs sourced from the roboRIO and passed via a CAN bus connection from the built-in CAN on the roboRIO (either directly or daisy-chained via another CAN bus device).

- R716** *Don't alter the CAN bus. No device that interferes with, alters, or blocks communications among the roboRIO and the PDP/PDH, PCMs/PHs, and/or CAN motor controllers on the bus will be permitted.

Only 1 wire should be inserted into each Weidmuller CAN connector terminal. For documentation on how to wire the CAN bus connections see [How to Wire an FRC ROBOT](#).

- R717** *USB to CAN adapter permitted. Additional CAN bus connections may be added to the roboRIO using the CTR Electronics CANivore™ (P/N 21-678682, WCP-1522) USB-to-CAN adapter.

Any additional CAN bus added in this manner satisfies the requirements of [R714](#) (i.e. you may connect motor controllers to this additional bus).

8.8 Pneumatic System

In order to maintain safety, the rules in this section apply at all times while at the event, not just while the ROBOT is on the FIELD for MATCHES.

- R801** *Only use explicitly permitted pneumatic parts. To satisfy multiple constraints associated with safety, consistency, inspection, and constructive innovation, no pneumatic parts other than those explicitly permitted in this section shall be used on the ROBOT.

- R802** *No custom pneumatics and meet minimum pressure ratings. All pneumatic items must be COTS pneumatic devices and either:
- rated by their manufacturers for pressure of at least 125psi (~862 kPa, 8.6 Bar), or
 - installed downstream of the primary relieving regulator (see R809), and rated for pressure of at least 70psi (~483 kPa, 4.8 Bar)

Any pressure specification such as “working,” “operating,” “maximum,” etc. may be used to satisfy the requirements of this rule.

It is recommended that all pneumatic items be rated by their manufacturers for a working pressure of at least 60 psi (~414 kPa, 4.1 Bar).

R803 *Don't modify pneumatics. All pneumatic COMPONENTS must be used in their original, unaltered condition. Exceptions are as follows:

- A. tubing may be cut,
- B. wiring for pneumatic devices may be modified to interface with the control system,
- C. assembling and connecting pneumatic COMPONENTS using the pre-existing threads, mounting brackets, quick-connect fittings, etc.,
- D. removing the mounting pin from a pneumatic cylinder, provided the cylinder itself is not modified, and
- E. labeling applied to indicate device purpose, connectivity, functional performance, etc.

Do not, for example, paint, file, machine, or abrasively remove any part of a pneumatic COMPONENT – this would cause the part to become a prohibited item.

R804 *Only use specific pneumatic devices. The only pneumatic system items permitted on ROBOTS include the following items:

- A. pneumatic pressure vent plug valves functionally equivalent to those provided in the KOP,

Examples of acceptable valves include Parker PV609-2 or MV709-2.

- B. pressure relief valves functionally equivalent to those provided in the KOP,

Examples of acceptable valves include Norgren 16-004-011, 16-004-003 or McMaster-Carr 48435K714.

To be considered functionally equivalent the valve must be preset or adjustable to 125 psi (~862 kPa, 8.6 Bar) and capable of relieving at least 1 scfm (~472 cm³/s).

- C. solenoid valves with a maximum 1/8 in. (nominal, ~3 mm) NPT, BSPP, or BSPT port diameter or integrated quick connect 1/4 in. (nominal, ~6mm) outside diameter tubing connection,
- D. additional pneumatic tubing, with a maximum 1/4 in. (nominal, ~6 mm) outside diameter,
- E. pressure transducers, pressure gauges, passive flow control valves (specifically “needle valve”), manifolds, and connecting fittings (including COTS pneumatic U-tubes),
- F. check and quick exhaust valves, provided that the requirements of R813 are still met.
- G. shutoff valves which relieve downstream pressure to atmosphere when closed (may also be known as 3-way or 3-way exhausting valves),
- H. pressure regulators with the maximum outlet pressure adjusted to no more than 60 psi (~413 kPa, 4.1 Bar),
- I. pneumatic cylinders, pneumatic linear actuators, and rotary actuators,
- J. pneumatic storage tanks (with the exception of white Clippard tanks P/N AVT-PP-41),
- K. 1 compressor that is compliant with R806,
- L. debris or coalescing (water) filters, and
- M. Venturi valves (note: the high-pressure side of a Venturi valve is considered a pneumatic device and must follow all pneumatic rules. The vacuum side of a Venturi valve is exempt from the pneumatic rules per “a” in the blue box below).

The following devices are not considered pneumatic devices and are not subject to pneumatic rules (though they must satisfy all other rules):

- A. a device that creates a vacuum,
- B. closed-loop COTS pneumatic (gas) shocks,
- C. air-filled (pneumatic) wheels, and
- D. pneumatic devices not used as part of a pneumatic system (i.e. used in a way that does not allow them to contain pressurized air)

R805 *If using pneumatics, these parts are required. If pneumatic COMPONENTS are used, the following items are required as part of the pneumatic circuit and must be used in accordance with this section, as illustrated in [Figure 8-17](#).

- A. 1 FIRST Robotics Competition legal compressor (per [R806](#)),
- B. a pressure relief valve (per [R804-B](#)) connected and calibrated (per [R811](#)),
- C. a Nason pressure switch (P/N SM-2B-115R/443) and/or REV Robotics Analog Pressure Sensor (P/N REV-11-1107) connected and wired per [R812](#),
- D. at least 1 pressure vent plug plumbed (per [R813](#)),
- E. stored pressure gauge and working pressure gauge (per [R810](#)), and
- F. 1 primary working pressure regulator (per [R808](#)).

Figure 8-17 Pneumatic circuitry

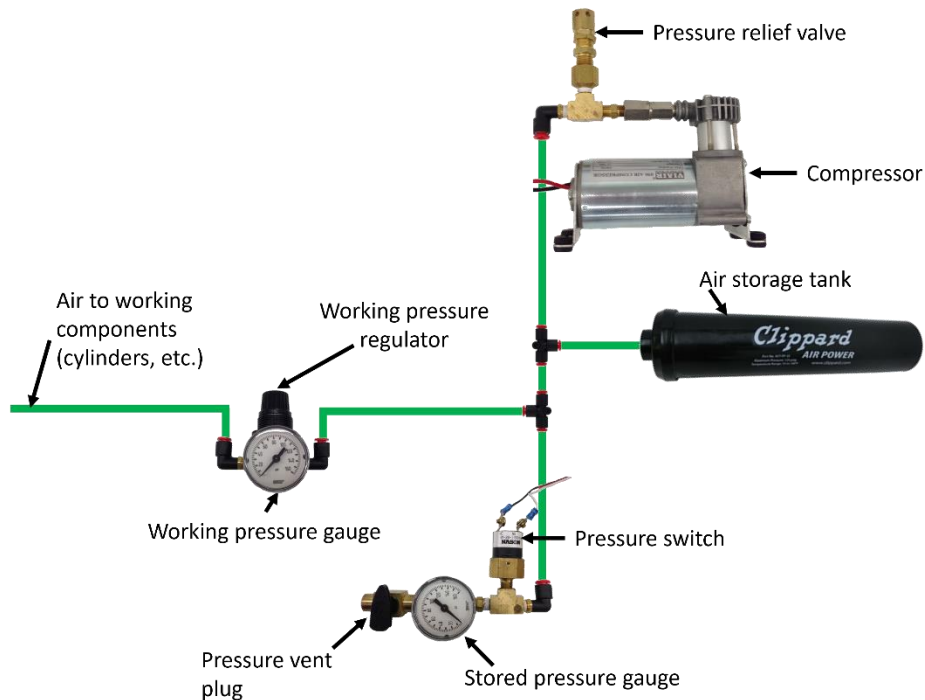

R806 *Compressed air from ROBOT compressor only. Throughout an event, compressed air on the ROBOT must be provided by its 1 onboard compressor only. Compressor specifications must not exceed nominal 1.1 cfm (~519 cm³/s) flow rate @ 12VDC at any pressure.

A ROBOT'S compressor may be substituted by another compressor, but a ROBOT may only have 1 designated compressor at a time, and all compressed air on the ROBOT must be sourced from a single compressor.

Note: Viair C-series compressors, which have a max working pressure of 120 PSI, are rated for intermittent pressures greater than 125 PSI and therefore meet the requirements of this rule.

- R807** ***Air storage pressure limit.** Stored air pressure on the ROBOT must be no greater than 120 psi (~827 kPa, 8.2 Bar). No stored air pressure intended for the ROBOT may be located off-board the ROBOT.
- R808** ***Working air pressure limit.** Working air pressure (air pressure used to actuate devices) on the ROBOT must be no greater than 60 psi (~413 kPa, 4.1 Bar) and must be provided through a single primary adjustable, relieving, pressure regulator. Additional regulators may be located downstream of the single primary regulator.

Examples of acceptable valves include Norgren regulator P/N R07-100-RNEA and Monnier P/N 101-3002-1.

- R809** ***Limited devices at high pressure.** Only the compressor, relief valve, pressure switch, pressure vent plug, pressure gauge, storage tanks, tubing, pressure transducers, filters, and connecting fittings may be in the high-pressure pneumatic circuit upstream from the regulator.

It is recommended that all COMPONENTS in the high-pressure pneumatic circuit upstream from the regulator be rated for at least 115 psi (~793 kPa, 7.9 Bar) working pressure.

- R810** ***Pressure gauges must be visible.** Pressure gauges must be placed in easily visible locations upstream and downstream of the regulator to display the stored and working pressures, respectively. Pressure gauges must show pressure in psi, kPa, or Bar.
- R811** ***Relief valve requirements.** The relief valve must be attached directly to the compressor or attached by legal hard fittings (e.g. brass, nylon, etc.) connected to the compressor output port.
- Teams are required to check and/or adjust the relief valve to release air at 125 psi (~862 kPa, 7.9 Bar). The valve may or may not have been calibrated prior to being supplied to teams.

Instructions for adjusting the pressure relief valve can be found in the [Pneumatics Manual](#).

- R812** ***Pressure switch requirements.** The pressure switch must be connected to the high-pressure side of the pneumatic circuit (i.e. prior to the pressure regulator) to sense the stored pressure of the circuit.

It must be either:

- A. Nason P/N SM-2B-115R/443 (wired as described) and/or

The 2 wires from the pressure switch must be connected directly to the pressure switch input of the PCM/PH controlling the compressor or, if controlled using the roboRIO and a relay, to the roboRIO. If connected to the roboRIO, the roboRIO must be programmed to sense the state of the switch and operate the relay module that powers the compressor to prevent over-pressuring the system.

- B. REV Robotics P/N REV-11-1107 (wired as described)

The analog output of the sensor must be connected directly to analog input 0 of the PH (with firmware version 22.0.2 or newer) controlling the compressor.

The REV Robotics Analog Pressure Sensor may only be used with PH compressor control and may not be used with PCM compressor control.

- R813** ***Vent plug requirements.** Any pressure vent plug must be:

- A. connected to the pneumatic circuit such that, when manually operated, it will vent to the atmosphere to relieve all stored pressure in a reasonable amount of time and

B. placed on the ROBOT so that it is visible and easily accessible.

R814 ***Don't connect solenoid outputs together.** The output air from multiple solenoid valves must not be combined.

Manifolds, shuttle valves, and other devices which do not combine output airflow, even though it may be plumbed into the same device, are not violations of this rule.

8.9 OPERATOR CONSOLE

R901 ***Use the specified Driver Station Software.** The Driver Station Software provided by National Instruments ([install instructions found here](#)) is the only application permitted to specify and communicate the operating mode (i.e. AUTO/TELEOP) and operating state (Enable/Disable) to the ROBOT. The Driver Station Software must be version 25.0 or newer.

Teams are permitted to use a portable computing device of their choice (laptop computer, tablet, etc.) to host the Driver Station Software while participating in MATCHES.

R902 ***The OPERATOR CONSOLE must have a visible display.** The OPERATOR CONSOLE, the set of COMPONENTS and MECHANISMS used by the DRIVERS and/or HUMAN PLAYERS to relay commands to the ROBOT, must include a graphic display to present the Driver Station Software diagnostic information. It must be positioned within the OPERATOR CONSOLE so that the screen display can be clearly seen during inspection and in a MATCH.

R903 ***Connect FMS Ethernet directly to the OPERATOR CONSOLE.** Devices hosting the Driver Station Software must only interface with the FMS via the Ethernet cable provided at the DRIVER STATION (e.g. not through a switch). Teams may connect the FMS Ethernet cable to the device running the Driver Station Software directly via an Ethernet pigtail, or with a single-port Ethernet converter (e.g. docking station, USB-Ethernet converter, Thunderbolt-Ethernet converter, etc.). The Ethernet port on the OPERATOR CONSOLE must be easily and quickly accessible.

Teams are strongly encouraged to use pigtails on the Ethernet port used to connect to the FMS. Such pigtails will reduce wear and tear on the device's port and, with proper strain relief employed, will protect the port from accidental damage.

R904 ***OPERATOR CONSOLE physical requirements.** The OPERATOR CONSOLE must not

- A. be longer than 5 ft. (~152 cm),
- B. be deeper than 1 ft. 2 in. (~35 cm) (excluding any items that are held or worn by the DRIVERS during the MATCH),
- C. extend more than 6 ft. 6 in. (~198 cm) above the floor, or
- D. attach to the FIELD (except via the loop tape as described in section [5.6.1 DRIVER STATIONS](#)).

There is a 4 ft. 6 in. (~137 cm) long by 2 in. (nominal) wide strip of hook-and-loop tape ("loop" side) along the center of the DRIVER STATION support shelf that should be used to secure the OPERATOR CONSOLE to the shelf. See section [5.6.1 DRIVER STATIONS](#) for details.

Please note that while there is no hard weight limit, OPERATOR CONSOLES that weigh more than 30 lbs. (~13 kg.) will invite extra scrutiny as they are likely to present unsafe circumstances.

R905 *FIELD wireless only. Other than the system provided by the FIELD, no other form of wireless communications shall be used to communicate to, from, or within the OPERATOR CONSOLE.

Examples of prohibited wireless systems include, but are not limited to, active wireless network cards and Bluetooth devices. For the case of the *FIRST* Robotics Competition, a motion sensing input device (e.g. Microsoft Kinect) is not considered wireless communication and is allowed.

R906 *No unsafe OPERATOR CONSOLES. OPERATOR CONSOLES shall not be made using hazardous materials, be unsafe, cause an unsafe condition, or interfere with other DRIVE TEAMS or the operation of other ROBOTS.

R907 *No AC inverters. OPERATOR CONSOLES must not contain AC inverters.



9 Inspection & Eligibility (I)

This section describes the rules governing MATCH participation. A team has participated in a MATCH if any member of their DRIVE TEAM is in the ALLIANCE AREA, with or without the ROBOT on the FIELD, at the start of the MATCH.

At each event, the Lead ROBOT INSPECTOR (LRI) has final authority on the legality of any COMPONENT, MECHANISM, or ROBOT. The LRI may consult with additional sources including the Global LRIs and/or *FIRST* personnel before making their final decision. INSPECTORS may re-inspect ROBOTS at any time to ensure compliance with the rules. Teams are encouraged to consult with INSPECTORS or the LRI if they have any questions regarding the legality of a ROBOT or about how to make a ROBOT legal.

The inspection process may progress in blocks, i.e. it may pause for a team's Practice MATCH, lunch break, etc. The process may employ various INSPECTORS throughout the process based on availability. At the team's discretion, they may request a different INSPECTOR or invite the Lead ROBOT INSPECTOR to participate in their ROBOT'S inspection.

While there is no specific defined procedure in place for teams to be re-inspected prior to Playoff MATCHES, it is typical for INSPECTORS to use the re-inspection discretion described above to do a limited re-inspection on all ROBOTS near the end of QUALIFICATIONS or beginning of Playoff MATCHES to help identify any modifications that should be re-inspected per [I104](#).

ROBOTS are permitted to participate in scheduled Practice MATCHES prior to passing inspection. However, the FTA, LRI, or Head REFEREE may determine at any time that the ROBOT is unsafe and may prohibit further participation in Practice MATCHES until the condition is corrected and/or the ROBOT passes inspection. A safe ROBOT has functional BUMPERS that approximately meet the required coverage ([R401](#)), height ([R402](#)), and cross section ([R408](#)) requirements.

Prior to the start of a MATCH, any ROBOT which is unable or ineligible to participate in that MATCH, as determined by the FTA, LRI, or Head REFEREE, is declared to be BYPASSED and is DISABLED. A team whose ROBOT is BYPASSED remains eligible to receive Qualification Ranking Points or Playoff MATCH points provided that its ROBOT has passed inspection, per [I102](#).

An Inspection Checklist (coming soon) is available to help teams self-inspect their ROBOT before their event. Teams are strongly encouraged to self-inspect prior to their event.

9.1 Rules

I101 *It's your team's ROBOT. The ROBOT and its MAJOR MECHANISMS must be built by the *FIRST* Robotics Competition team.

A MAJOR MECHANISM is a group of COMPONENTS and/or MECHANISMS assembled together to address at least 1 game challenge: ROBOT movement, SCORING ELEMENT manipulation, FIELD element manipulation, or performance of a scorable task without the assistance of another ROBOT.

This rule requires that the ROBOT and its MAJOR MECHANISMS were built by its team, but isn't intended to prohibit or discourage assistance from other teams (e.g. fabricating elements, supporting construction, writing software, developing game strategy, contributing COMPONENTS and/or MECHANISMS, etc.)

Examples of MAJOR MECHANISMS include, but are not limited to, assemblies used to:

- A. manipulate SCORING ELEMENTS,
- B. manipulate a FIELD element, and
- C. move the ROBOT around the FIELD.

Examples that would generally not be considered MAJOR MECHANISMS, and thus probably aren't subject to this rule include, but are not limited to, the following:

- A. a gearbox assembly,
- B. a COMPONENT or MECHANISM that's part of a MAJOR MECHANISM, and
- C. COTS items.

Neither this rule nor the language in this blue box define specific thresholds for how much of a MAJOR MECHANISM must be the result of the team's effort. This rule expects and requires the team's honest assessment of whether they built the MAJOR MECHANISMS of their ROBOT.

Attempts to exploit loopholes in the definition of MAJOR MECHANISM in order to bypass this requirement are in the spirit of neither this rule nor the FIRST Robotics Competition. Examples of exploitation include:

- A. assembling pieces of a MAJOR MECHANISM provided by another team, except COTS kits and
- B. receiving a mostly complete MAJOR MECHANISM from another team and providing a small piece.

I102 *Get inspected before playing a Qualification/Playoff MATCH. A team is only permitted to participate in a Qualification or Playoff MATCH and receive Ranking or MATCH Points if their ROBOT has passed an initial, complete inspection.

Violation: If prior to the start of the MATCH, the team is DISQUALIFIED and not eligible to participate in the MATCH. If after the MATCH, the team receives a RED CARD and the MATCH may be replayed per [T201](#).

I103 *Bring it all to inspection. At the time of inspection, the OPERATOR CONSOLE and the ROBOT must be presented with all MECHANISMS (including all COMPONENTS of each MECHANISM), configurations, and decorations that will be used on the ROBOT in MATCHES without re-inspection (per [I104](#)) and may not exceed 150 lbs. (~68 kg) (note that while up to 150 lbs. (~68 kg) of ROBOT MECHANISMS may be inspected together, the ROBOT configuration used in a MATCH may not violate [R103](#)). The OPERATOR CONSOLE and exceptions listed in [R103](#) are not included in this weight.

I104 *Unless the change is listed below, any change to a ROBOT must get re-inspected. A ROBOT may play MATCHES with a subset of the MECHANISMS that were present during inspection provided the reconfigured ROBOT still complies with all ROBOT Construction Rules. Only MECHANISMS that were present during the inspection may be added, removed, or reconfigured between MATCHES without re-inspection per this rule. If a ROBOT is modified after its most recent passed inspection, it must be re-inspected before it is eligible to participate in a MATCH.

Exceptions are listed in A through F (unless they result in a significant change to the ROBOT'S size, weight, legality, or safety).

- A. addition, relocation, or removal of fasteners (e.g. cable ties, tape, and rivets),
- B. addition, relocation, or removal of labeling or marking,
- C. revision of ROBOT code,
- D. replacement of a COTS COMPONENT with an identical COTS COMPONENT,
- E. replacement of a MECHANISM with an identical MECHANISM (size, weight, material), and

- F. additions, removals, or reconfiguration of ROBOT with a subset of MECHANISMS already inspected per [I103](#).

I105 ***Don't exploit re-inspection.** Teams may not use the re-inspection process in [I104](#) to circumvent the weight limit in [I103](#).

This restriction is not intended to prevent a team from returning to a previous configuration (e.g. due to an unsuccessful upgrade or failure of a new COMPONENT). If a team is believed to be violating this rule, the LRI will discuss the situation with the team to understand the changes and, if appropriate, the LRI in conjunction with the team will select a single configuration with which the team will compete for the duration of the event.

Example 1: A ROBOT passes initial inspection (which includes MECHANISM A). Its team then decides they want to use MECHANISM B, which was not inspected. The weight of the ROBOT, A, and B is less than the weight limit in [I103](#), but more than that in [R103](#). [I104](#) requires the ROBOT be re-inspected, and this rule allows the ROBOT, A, and B to be inspected collectively. If passed, the ROBOT may then compete in subsequent MATCHES with A or B.

Example 2: A ROBOT passes initial inspection (which includes MECHANISM A). Its team then decides they want to use MECHANISM B, which was not inspected. The weight of the ROBOT, A, and B is greater than the weight limit in [I103](#). This requires re-inspection per [I104](#) and A is excluded to satisfy [I103](#). B breaks, and the team decides to switch back to A. The ROBOT must be re-inspected per [I104](#), and the team is not violating this rule.

Example 3: A team arrives at an event with a ROBOT, MECHANISM A, and MECHANISM B, which collectively weigh 175 lbs (79 kg). The ROBOT passes initial inspection with A and plays a MATCH. The team switches to B, gets re-inspected, and plays again. The team switches back to A, gets re-inspected, and plays again. The team switches back to B and asks to be re-inspected. At this point, the LRI suspects the team may be violating this rule and has a discussion with the team to understand the changes being made. The team reveals that this rule has been violated, and the LRI works with them to select A or B for use for the remainder of the event.

I106 ***ROBOTS are off for inspection (mostly).** For the safety of all those involved, ROBOTS, must be presented for inspection with the ROBOT powered off, pneumatics unpressurized, and springs or other stored energy devices in their lowest potential energy states (e.g. battery removed).

Power and air pressure should only be enabled on the ROBOT during those portions of the inspection process where it is absolutely required to validate certain system functionality and compliance with specific rules (firmware check, etc.). INSPECTORS may allow the ROBOT to be powered beyond the parameters above if both criteria below are met:

- A. the ROBOT design requires power or a charged stored energy device in order to confirm that the ROBOT meets volume requirements and
- B. the team has included safety interlocks that mitigate unexpected release of such stored energy.

The team may be asked to demonstrate these interlocks during the inspection process.

I107 *No STUDENT, no inspection. At least 1 STUDENT team member must accompany the ROBOT for any inspection efforts.

Exceptions may be made for major conflicts, e.g. religious holidays, major testing, transportation issues, etc.



10 Tournaments (T)

Each 2025 *FIRST* Robotics Competition event is played in a tournament format. Each tournament consists of 3 types of MATCHES: Practice MATCHES (not necessarily played at all District Events), Qualification MATCHES, and Playoff MATCHES.

Practice MATCHES provide each team with an opportunity to operate its ROBOT on the FIELD prior to the start of the Qualification MATCHES.

Qualification MATCHES allow each team to earn Ranking Points which determine their seeding position and may qualify them for participation in the Playoff MATCHES.

Playoff MATCHES determine the event Champions.

10.1 MATCH Schedules

A MATCH schedule is used to coordinate MATCHES at an Event. [Figure 10-1](#) details information shown on each schedule. SURROGATE MATCHES are described in section [10.5.2 MATCH Assignment](#).

Figure 10-1 Sample MATCH schedule

Qualification Match Schedule

Matches Per Team		10	Event Name					
Time	Description	Match	Blue 1	Blue 2	Blue 3	Red 1	Red 2	Red 3
Thu 2:30	Qualification 1	1	1	2	3	4	5	6
Thu 2:37	Qualification 2	2	7	8	9	10	11*	12
Thu 2:44	Qualification 3	3	13	14	15*	16	17	18

ALLIANCE Red or Blue
 DRIVER STATION number 1, 2, or 3
 Asterisk (*) indicates SURROGATE MATCH

MATCH Start Time MATCH Type MATCH Number

10.2 MATCH Replays

Over the course of the tournament, it may be necessary for a MATCH to be replayed. Typical causes for replays are MATCHES that end in a tie during the Playoffs (due to criteria listed in [Table 10-3](#) or any Finals MATCH), MATCHES that are stopped because FIELD STAFF anticipated FIELD damage or personal injury, or if there is an ARENA FAULT. An ARENA FAULT is an error in ARENA operation that includes, but is not limited to:

- A. broken FIELD elements due to
 - a. normal, expected game play or
 - b. ROBOT abuse of FIELD elements that affects the outcome of the MATCH for their opponents

A broken FIELD element caused by ROBOT abuse that affects the outcome of the MATCH for their ALLIANCE is not an ARENA FAULT.

- B. power failure to a portion of the FIELD (tripping the circuit breaker in the DRIVER STATION is not considered a power failure),
- C. improper activation by the FMS,
- D. errors by FIELD STAFF (except those listed in section [6.8 Other Logistics](#)), and

- E. a ROBOT radio disconnect that impairs operation of other ROBOTS on the FIELD for more than 8 seconds.

If, in the judgment of the Head REFEREE, an ARENA FAULT occurs that affects the outcome of the MATCH and any team on the affected ALLIANCE desires a replay, the MATCH will be replayed. *FIRST* Headquarters reserves the right to, with consultation of the Head REFEREE and the FTA, replay a MATCH in which an ARENA FAULT impacts the outcome of an event.

The outcome of the MATCH is affected if an error occurs that, in the judgement of the Head REFEREE, changes which ALLIANCE would have won the MATCH and/or the assignment of Ranking Points.

The outcome of an event is affected if an error occurs that, in the judgement of *FIRST* Headquarters, changes the assignment of Ranking Points or has a dramatic effect on points used for ranking criteria.

Note that an ARENA FAULT that does not affect MATCH outcome, in the judgement of the Head REFEREE, does not lead to a MATCH replay. Examples include, but are not limited to:

- A. a piece of FIELD plastic falls into the FIELD, far away from any human or ROBOT activity, and in such a way that it does not affect MATCH outcome,
- B. delay in the playing of an ARENA sound,
- C. mismatch between the timer on the audience screen and the ARENA timer,
- D. any adjustment or delay in assignment of a penalty (including those made after the MATCH), and
- E. the disconnect described in scenario E occurring before the last 20 seconds of the MATCH.

Examples of errors by FIELD STAFF include, but are not limited to:

- F. a gate being left open when the MATCH starts,
- G. mistakenly allowing a ROBOT in violation of [1102](#) that hasn't passed an initial, complete inspection to participate in the MATCH

- T201** ***Replays will be the same.** All reasonable effort is made to create the same conditions when replaying a MATCH caused by an ARENA FAULT or FIELD damage. This means, for example, that a team that was BYPASSED prior to the start of the MATCH which is to be replayed is BYPASSED for the replay MATCH. ROBOT and DRIVE TEAM starting locations do not need to be replicated when replaying a MATCH.

Violation: MATCH with not start until the situation is corrected

Per section [6.6.1 YELLOW and RED CARDS](#), cards assigned in previous MATCHES, including prior instances of the MATCH to be replayed, are not cleared.

10.3 Measurement

At each event, the ARENA will be open for at least 30 minutes prior to the start of Qualification MATCHES, during which time teams may survey and/or measure the ARENA and bring ROBOTS on the FIELD to perform sensor calibration. The specific time that the FIELD is open will be communicated to teams at the event. Teams may bring specific questions or comments to the FTA.

- T301** ***Freeze, ROBOT.** During the period when the ARENA is open for measurement, ROBOTS can be enabled, but may neither drive, extend outside their ROBOT PERIMETER, nor interact with (e.g. score,

push, pickup, etc.) SCORING ELEMENTS, a CAGE, PROCESSOR, REEF, CORAL STATION, or other FIELD elements.

Violation: VERBAL WARNING, plus YELLOW CARD if subsequent violations at any point during the event or egregious.

10.4 Practice MATCHES

Practice MATCHES are played before Qualification MATCHES. The Practice MATCH schedule is available as soon as possible, but no later than the start of Practice MATCHES. For Regional events, it will also be published and available online on the [FRC-Events website](#), except during exceptional circumstances. Practice MATCHES are randomly assigned, and teams may not switch scheduled Practice MATCHES. Each team is assigned an equal number of Practice MATCHES unless the number of teams multiplied by number of Practice MATCHES is not divisible by 6. In this case, the FMS randomly selects some teams to play an extra Practice MATCH.

Practice MATCHES are not guaranteed at District Events due to event schedule constraints.

10.4.1 Filler Line

A Filler Line is used to fill open slots at events that employ scheduled Practice MATCHES or all slots at events with an open Practice MATCH schedule. Teams from the Filler Line are used on a first come, first served basis to fill empty spots in Practice MATCHES left by other teams that do not report to Queueing. The number of teams in the Filler Line is dependent upon space at venues.

Only teams that meet all criteria below qualify for the Filler Line:

- A. ROBOTS in the Filler Line must have passed inspection (this requirement may be waived for events with open Practice MATCH schedules),
- B. DRIVE TEAMS must join the Filler Line with their ROBOT,
- C. teams may not work on their ROBOT while in the Filler Line,
- D. teams may not occupy more than 1 spot in the Filler Line, and
- E. if a team is queued for their Practice MATCH, they may not also join the Filler Line.

10.5 Qualification MATCHES

10.5.1 Schedule

The Qualification MATCH schedule is made available as soon as possible, but no later than 30 minutes before Qualification MATCHES are scheduled to begin. Teams receive 1 hard copy and it is also available on the [FRC-Events website](#), except during exceptional circumstances. Each Qualification schedule consists of a series of rounds in which each team plays 1 MATCH per round.

10.5.2 MATCH Assignment

FMS assigns each team 2 ALLIANCE partners for each Qualification MATCH using a predefined algorithm, and teams may not switch Qualification MATCH assignments. The algorithm employs the following criteria, listed in order of priority:

1. ensure each team has at least the minimum required time between MATCHES (varies by event size)
2. minimize the number of times a team is allied with any team
3. minimize the number of times a team plays opposite any team
4. minimize the use of SURROGATES (teams randomly assigned by the FMS to play an extra Qualification MATCH)

5. provide even distribution of MATCHES played on blue and red ALLIANCE
6. provide even distribution of MATCHES played in each DRIVER STATION number

For more information about the MATCH scheduling algorithm, please see [Idle Loop software's website](#).

At events with fewer than 24 participating teams, the criteria are similar, however criterion 5 is changed to minimize the number of times a team swaps between the blue and red ALLIANCE rather than an even distribution.

All teams are assigned the same number of Qualification MATCHES, equal to the number of rounds, unless the number of teams multiplied by number of MATCHES is not divisible by 6. In this case, the FMS randomly selects some teams to play an extra MATCH. For the purpose of seeding calculations, those teams are designated as SURROGATES for the extra MATCH. If a team plays a MATCH as a SURROGATE, it is indicated on the MATCH schedule, it is always their third Qualification MATCH, and the outcome of the MATCH has no effect on the team's ranking. YELLOW and RED CARDS assigned to SURROGATES, however, do carry forward to subsequent MATCHES.

10.5.3 Qualification Ranking

Ranking Points are units credited to a team based on their ALLIANCE'S performance in Qualification MATCHES. Ranking Points are awarded to each eligible team at the completion of each Qualification MATCH per [Table 6-2](#).

Exceptions to Ranking Point assignment are as follows:

- A. A SURROGATE receives 0 Ranking Points.
- B. A DISQUALIFIED team, as determined by the Head REFEREE, receives 0 Ranking Points.
- C. A "no-show" team is either DISQUALIFIED from or issued a RED CARD for that MATCH (see [G208](#)). A team is declared a no-show if no member of the DRIVE TEAM is in the ALLIANCE AREA at the start of the MATCH.

The total number of Ranking Points earned by a team throughout their Qualification MATCHES divided by the number of MATCHES they've been scheduled to play (minus any SURROGATE MATCH), then rounded to 2 decimal places, is their Ranking Score (RS).

All teams participating in Qualification MATCHES are ranked by Ranking Score. If the number of teams in attendance is 'n', they are ranked '1' through 'n', with '1' being the team with the highest Ranking Score and 'n' being the team with the lowest Ranking Score.

Teams are ranked in order, using the sorting criteria defined in [Table 10-1](#).

Table 10-1 Qualification MATCH ranking criteria

Order Sort	Criteria
1 st	Ranking Score
2 nd	Average <i>Coopertition</i> Bonus points
3 rd	Average ALLIANCE MATCH points, not including MINOR FOULS and MAJOR FOULS
4 th	Average ALLIANCE LEAVE + AUTO SCORING ELEMENT points
5 th	Average ALLIANCE BARGE points

Order Sort	Criteria
6 th	Random sorting by the FMS

10.6 Playoff MATCHES

Playoff MATCHES follow the qualification MATCHES. In the Playoffs, teams play on set ALLIANCES, chosen during ALLIANCE selection, and advance through a double elimination bracket. Teams do not earn Ranking Points; they advance based on winning, losing, or tying a MATCH.

A DISQUALIFIED team, as determined by the Head REFEREE, causes their alliance to receive 0 MATCH points in a Playoff MATCH.

10.6.1 ALLIANCE Selection Process

At the end of the Qualification MATCHES, the top 8 ranked teams become the ALLIANCE Leads. The ranked ALLIANCES are designated, in order, ALLIANCE 1, ALLIANCE 2, etc., down to ALLIANCE 8. Using the ALLIANCE selection process described in this section, each ALLIANCE Lead chooses 2 other teams to join their ALLIANCE.

A break of 8 minutes (8:00) occurs between the posting of scores from the last qualification match (scheduled or replay, whichever comes later) and the start of the ALLIANCE Selection process for events that host Alliance Selection shortly after QUALIFICATION MATCHES. At the end of this break, ALLIANCE 1 is “on the clock” as defined below in [T605](#).

T601 ***Send your STUDENT representatives.** Each team must choose and send a minimum of one and a maximum of three STUDENT team representatives. Representative(s) must report to the ARENA before the start of ALLIANCE Selection.

Violation: Team is ineligible for the Playoff Tournament if they are not represented by the time they are announced.

If an absent team would have been an ALLIANCE Lead, all lower ranked ALLIANCE Leads are promoted 1 spot.

The designated STUDENT representative from each ALLIANCE Lead is called the ALLIANCE CAPTAIN (if the ALLIANCE has sent multiple STUDENT representatives, they must designate only one as the ALLIANCE CAPTAIN). This representative may change between ALLIANCE selection and Playoff MATCHES.

T602 ***STUDENTS must outnumber adults.** A non-STUDENT may additionally be a representative from a team if the team has exactly two STUDENT representatives.

Violation: Non-STUDENT must leave the ARENA

These are the possible combinations of ALLIANCE Selection representatives between [T601](#)/[T602](#):

- A. One STUDENT
- B. Two STUDENTS
- C. Three STUDENTS
- D. Two STUDENTS and one non-STUDENT

The ALLIANCE selection process consists of rounds during which each ALLIANCE CAPTAIN invites a team ranked below them in the standings to join their ALLIANCE. The invited team’s representative must either accept or decline the invitation immediately. If the team accepts, it becomes a member of that ALLIANCE. This process results in 8 ALLIANCES of 3 teams.

Each round is complete when all ALLIANCES have added one additional team, and each round must be complete before the next round can begin. In round 1 selections are made in descending order (ALLIANCE 1 to ALLIANCE 8), whereas in round 2 selections are made in ascending order (ALLIANCE 8 to ALLIANCE 1).

T603 * **Only STUDENTS may use the mic.** Only a single STUDENT from the invited team is allowed to accept/decline.

Violation: The team is assumed to have declined.

T604 * **Only the ALLIANCE CAPTAIN may invite an ALLIANCE.** The ALLIANCE CAPTAIN is the only representative of the ALLIANCE who may approach the Emcee and make a valid pick via the microphone.

Violation: Pick does not count, and pick timer continues to count down.

T605 * **Picks are time limited.** Once the emcee requests an ALLIANCE'S selection, the ALLIANCE is considered "on the clock" and the pick timer begins to countdown. In round 1, the timer begins at 45 seconds (0:45), in round 2 the timer begins at 1 minute and 30 seconds (1:30). A sound will play to indicate that there are 5 seconds left on the timer and a buzzer will go off to indicate the end of the time. The ALLIANCE CAPTAIN must make a good faith effort, as determined by the FTA or their designee, to state a valid team selection before the expiration of the pick timer.

Violation: The ALLIANCE is skipped, and the emcee moves to the next ALLIANCE, unless the selection is the last of a round in which case the ALLIANCE receives the next highest-ranked unselected team to the ALLIANCE.

The time remaining on the pick timer is displayed on the FIELD timers. Please note that audio cues are intended as a courtesy to participants and not intended as official markers.

A valid team selection includes any team who has not yet accepted or declined an invitation to join another ALLIANCE and is not an ALLIANCE Lead that has had a pick timer violation. If an ALLIANCE CAPTAIN attempts to select a team that is not valid, the pick timer continues to run until it either expires, or a different (valid) team is invited to join the ALLIANCE.

Examples of good faith efforts to state a valid team selection include but are not limited to:

- A. Walking safely towards the Emcee when the clock hits zero
- B. Starting to state a team as the clock hits zero

Examples that are not considered good faith efforts to quickly become MATCH ready include but are not limited to:

- C. Continuing to talk with your ALLIANCE partners without moving towards the Emcee
- D. Talking into the microphone for more than approximately 30 seconds without clearly stating a team number to invite

If an ALLIANCE CAPTAIN extends a valid invitation and the invited team declines, the pick clock resets to the time for the designated round and restarts immediately.

After each accepted ALLIANCE invitation or pick clock violation, the emcee invites any ALLIANCE CAPTAINS that received a pick clock violation in that round to make their selections. Each ALLIANCE CAPTAIN may either indicate that they are ready to make their selection (and immediately do so) or indicate that they are not yet ready, and they will be revisited after the next accepted invitation or pick clock violation. If there are multiple

ALLIANCE CAPTAINS that have received pick clock violations, they are revisited in the same order in which they received their violations.

The ALLIANCE CAPTAIN with the last selection of a given round may not be the ALLIANCE CAPTAIN *scheduled* to have the final pick. For example, imagine in round 1 that ALLIANCES 1-6 have all made valid selections and ALLIANCE Lead 7 receives a pick clock violation. If ALLIANCE Lead 8 makes a valid selection, then ALLIANCE Lead 7 now has the final selection of round 1.

A break of 2 minutes (2:00) occurs between each round of selections. At the conclusion of the break, the ALLIANCE scheduled to make the next selection goes “on the clock” and their timer begins per [T603](#).

T606 *Declining teams can't be picked. An ALLIANCE CAPTAIN may not invite a team that has declined another ALLIANCE'S invitation to participate in the Playoff tournament. Declining teams are ineligible to be a BACKUP TEAM.

Violation: The ALLIANCE CAPTAIN must make another selection and pick timer continues to count down.

An ALLIANCE Lead that declines an invitation from another ALLIANCE is able to invite teams to join their ALLIANCE but may not be invited to join another ALLIANCE.

At the conclusion of ALLIANCE selection, the highest ranked unselected teams are eligible to become a BACKUP TEAM, as defined in section [10.6.3 BACKUP TEAMS](#).

10.6.2 Playoff MATCH Bracket

The double elimination tournament consists of an Upper and Lower bracket as shown in [Figure 10-2](#). Each ALLIANCE begins with a slot in the Upper bracket. If an ALLIANCE wins a MATCH in the Upper bracket, they remain in the Upper bracket. If an ALLIANCE loses a MATCH in the Upper bracket, they transition to the Lower bracket. ALLIANCES in the Lower bracket must win any subsequent MATCHES (except for finals) to remain in the tournament, i.e. once they lose a MATCH, they're out of the tournament.

In Round 1, the higher ranked ALLIANCE is assigned to the red ALLIANCE. For subsequent rounds, ALLIANCE color is assigned as shown in [Figure 10-2](#), regardless of ALLIANCE rank at the start of the Playoff tournament.

Figure 10-2 Playoff MATCH bracket (Red ALLIANCE tops each pairing)

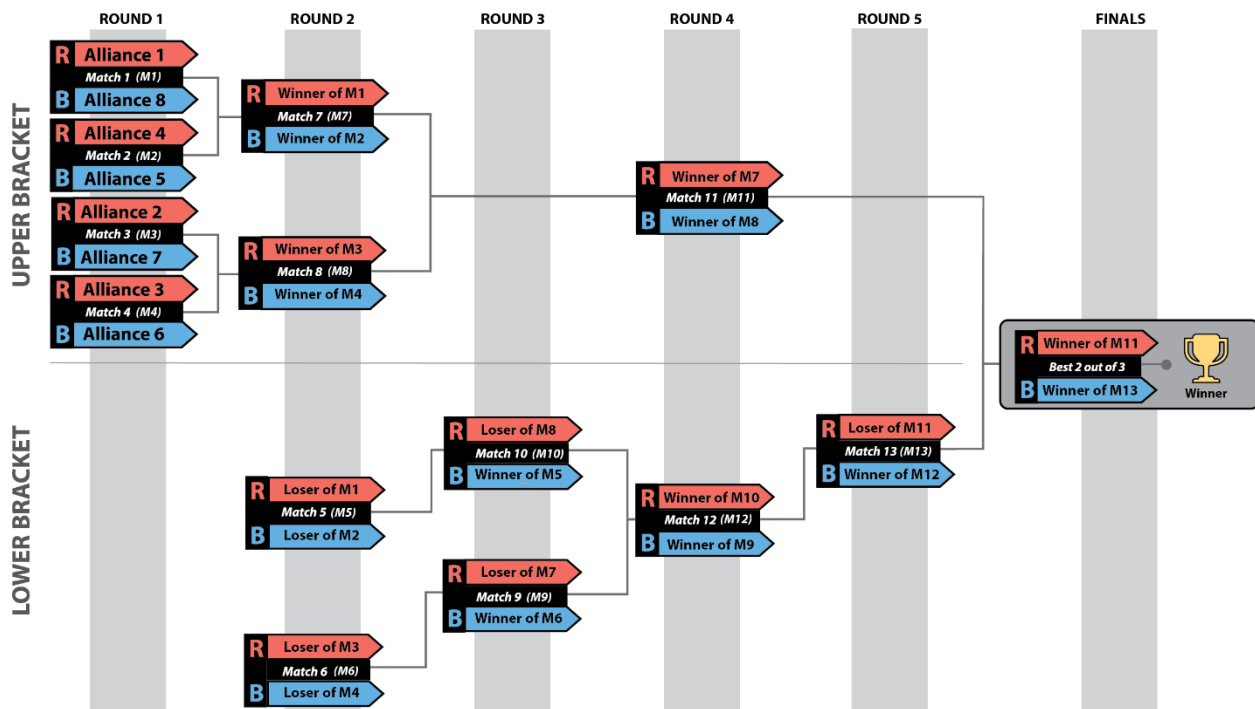

As shown in [Figure 10-2](#) and [Table 10-2](#), Playoff MATCHES consist of 6 rounds with breaks between later rounds and between Finals MATCHES. Breaks begin after the FIELD has been cleared from the previous MATCH. The Blue and Red Gap columns indicate the approximate time between each ALLIANCE'S MATCHES. The expected start time of the scheduled MATCH is the time indicated on the MATCH schedule or 15 minutes from the end of either ALLIANCE'S previous MATCH, whichever is later. Occasionally, replayed MATCHES within a round may be played out of order; if MATCHES are played out of order, teams are informed by the Emcee, FIELD STAFF, and/or Queueing staff.

If a Playoff MATCH needs to be replayed as described in section [10.2 MATCH Replays](#), teams are notified of when the replay will occur. A minimum 10-minute delay is provided for teams to reset their ROBOTS prior to the replay unless all teams are ready sooner. The affected MATCH must be replayed before the next round begins.

Table 10-2 Typical Playoff MATCH schedule

Round	MATCH	Upper/ Lower	Gap (min)				Next MATCH (MATCH # (ALLIANCE color))	
			Blue	Red	Blue	Red	Winner	Loser
1	1	Upper	8	1			M7 (R)	M5 (R)
	2	Upper	5	4			M7 (B)	M5 (B)
	3	Upper	7	2			M8 (R)	M6 (R)
	4	Upper	6	3			M8 (B)	M6 (B)
2	5	Lower	L2	L1	0:24	0:33	M10 (B)	
	6	Lower	L4	L3	0:15	0:24	M9 (B)	
	7	Upper	W2	W1	0:42	0:51	M11 (R)	M9 (R)
	8	Upper	W4	W3	0:33	0:42	M11 (B)	M10 (R)
3	9	Lower	W6	L7	0:24	0:15	M12 (B)	
	10	Lower	W5	L8	0:42	0:15	M12 (R)	
6-minute break								
4	11	Upper	W8	W7	0:27	0:36	M14 (R)	M13 (R)
	12	Lower	W9	W10	0:27	0:18	M13 (B)	
15-minute awards break: Imagery, Gracious Professionalism, Team Spirit, and Rising All Star								
5	13	Lower	W12	L11	0:18	0:27	M14 (B)	
15-minute awards break: Autonomous, Creativity, Quality, and Industrial Design								
Finals	14		W13	W11	0:18	0:48	M15	M15
15-minute awards break: Innovation in Control, Excellence in Engineering, Team Sustainability, Judges								
Finals	15		W13	W11	0:18	0:18	M16*	M16*
15-minute awards break: Rookie All Star, Dean's List, Engineering Inspiration**								
Finals	16*		W13	W11	0:18	0:18		
Awards: Remaining awards, Finalists, Winners, and FIRST Impact Award								

* if required

** Program Delivery Partners may choose to hold these awards until after all MATCHES are complete.

10.6.2.1 Playoff MATCH ties

If final MATCH scores for both ALLIANCES are equal, the win is awarded to the ALLIANCE per criteria listed in [Table 10-3](#).

Table 10-3 Playoff MATCH Tiebreaker Criteria

Order Sort	Criteria
1 st	Cumulative MAJOR FOUL points due to opponent rule violations
2 nd	ALLIANCE AUTO points
3 rd	ALLIANCE BARGE points
4 th	MATCH is replayed

10.6.2.2 Playoff Finals

Once a single ALLIANCE remains in each Upper and Lower bracket, those ALLIANCES proceed to the Finals round. The first ALLIANCE to win 2 MATCHES in the Finals becomes the event's Champions.

If a Finals MATCH ends in a tie score, the tie is not broken using the criteria in [Table 10-3](#), the MATCH remains a tie. In the case where an ALLIANCE hasn't won 2 MATCHES after 3 MATCHES have been played (because of tied MATCHES), the Playoffs proceed with up to 3 additional Finals MATCHES, called Overtime MATCHES, until an ALLIANCE has won 2 Finals MATCHES. In the case where the Overtime MATCH scores for both ALLIANCES are equal, the win for that Overtime MATCH is awarded based on the criteria listed in [Table 10-3](#).

10.6.3 BACKUP TEAMS

During the Playoff MATCHES an ALLIANCE CAPTAIN may elect to replace one of its ROBOTS. The team whose ROBOT and DRIVE TEAM replaces another ROBOT and DRIVE TEAM on an ALLIANCE during the Playoff MATCHES is called the BACKUP TEAM.

In this situation, the ALLIANCE CAPTAIN has the option to bring in the highest ranked team from the pool of available teams to join its ALLIANCE for the following MATCH. The resulting ALLIANCE is then composed of 4 teams.

ALLIANCES submit LINEUPS (as described in section [10.6.4 LINEUPS](#)) for each Playoff MATCH. After the BACKUP TEAM's first Playoff MATCH, the ALLIANCE'S LINEUP may consist of any 3 of the ALLIANCE'S 4 teams.

10.6.3.1 BACKUP TEAM Coupons

Each ALLIANCE is allotted 1 BACKUP TEAM coupon during the Playoff MATCHES. If two or more ROBOTS from the ALLIANCE become inoperable, then the ALLIANCE must play the following MATCHES with only 2 (or even 1) ROBOTS.

Example: 3 teams, A, B and C, form an ALLIANCE going into the Playoff MATCHES. The highest ranked team not on 1 of the 8 ALLIANCES is Team D. During 1 of the Playoff MATCHES, Team C's ROBOT suffers damage to its mechanical arm. The ALLIANCE CAPTAIN decides to bring in Team D to replace Team C in the next MATCH. The new ALLIANCE of Teams A, B, C, and D are successful in advancing to the Finals and win the event. Teams A, B, C, and D are all recognized as members of the Winning ALLIANCE and receive awards.

The Head REFEREE will not accept the BACKUP TEAM coupon unless it lists the number of the team whose ROBOT is being replaced and is initialed by the ALLIANCE CAPTAIN. Once a BACKUP TEAM coupon is

submitted and accepted by the Head REFEREE, the BACKUP TEAM coupon may not be withdrawn by the ALLIANCE.

T607 ***No BACKUP TEAM for replayed MATCHES.** An ALLIANCE may not request a BACKUP TEAM for a replayed MATCH. The sole exception is if, in the judgment of the Head REFEREE, the replay is due to an ARENA FAULT that rendered an ALLIANCE'S ROBOT inoperable.

Violation: The request is denied.

T608 ***No BACKUP TEAMS for 1st MATCH.** An ALLIANCE may not request a BACKUP TEAM until after their first Playoff MATCH.

Violation: The request is denied.

T609 ***BACKUP TEAMS play when called.** A BACKUP TEAM must be included in the LINEUP for the ALLIANCE'S next MATCH following their recruitment.

Violation: The LINEUP is denied.

If the Head REFEREE is busy, and there is no designee, the ALLIANCE CAPTAIN remains in the Question Box to report the LINEUP.

T610 ***BACKUP TEAMS due 2 minutes before the MATCH start time.** The BACKUP TEAM Coupon must be submitted to the Head REFEREE (or their designee) by the ALLIANCE CAPTIAN not later than 2 minutes before the expected MATCH start time in which the BACKUP TEAM is to play.

Violation: The request is denied

If the Head REFEREE is busy, and there is no designee, the ALLIANCE CAPTAIN remains in the Question Box to submit the BACKUP TEAM coupon.

10.6.3.2 BACKUP POOL

After the top ranked ALLIANCE has made their final pick during ALLIANCE Selection, REFEREES poll the remaining eligible teams. In rank order, REFEREES invite remaining teams to accept or decline a position in the BACKUP POOL, i.e. the group of teams willing and able to join an ALLIANCE during the Playoff MATCHES, if needed, until up to 8 teams accept.

T611 ***Be there to be a BACKUP TEAM.** A team must be present after ALLIANCE Selection to accept the REFEREE'S invitation to join the BACKUP POOL.

Violation: Team is ineligible to be a BACKUP TEAM.

T612 ***Send a BACKUP TEAM Representative.** The top 2 ranked BACKUP TEAMS must send at least 1 STUDENT representative (and optionally 1 additional STUDENT or mentor) to a designated area near the FIELD for the duration of the Playoff MATCHES.

These 2 representatives are available to answer questions and accept invitations to be a BACKUP TEAM from ALLIANCE CAPTAINS. If 1 of these 2 teams joins an ALLIANCE or excuses themselves from the BACKUP POOL, the next highest ranked team in the BACKUP POOL must provide their representative. Once a BACKUP TEAM has declined an invitation to join an ALLIANCE, it is no longer a member of the BACKUP POOL and ineligible to join another ALLIANCE.

Violation: VERBAL WARNING, plus the team is removed from BACKUP POOL if the situation cannot be corrected within a reasonable amount of time.

Some events may offer an area near the FIELD where the top 1 or 2 teams in the BACKUP POOL may choose to stage their ROBOT for quick and easy access to the FIELD if recruited.

10.6.4 LINEUPS

Each ALLIANCE competing in a Playoff MATCH has the option to submit a LINEUP, which lists the 3 teams participating in the MATCH and their selected DRIVER STATIONS.

The LINEUP is kept confidential until the FIELD is set for the MATCH at which point each ALLIANCE'S LINEUP appears on the Team Signs.

10.6.4.1 LINEUPS for 4-team ALLIANCES

If an ALLIANCE has 4 members (either because a 3-team ALLIANCE has called a BACKUP TEAM or the event is the FIRST Championship), a single representative from the team not on the LINEUP is allowed as a sixteenth ALLIANCE member but must be a member of that team's DRIVE TEAM. This additional representative may only serve as a COACH.

10.6.4.2 Default LINEUP

T613 ***LINEUPS due 2 minutes before the MATCH.** The ALLIANCE CAPTAIN must submit their LINEUP in writing to the Head REFEREE (or their designee) 2 minutes before their expected MATCH start time.

Violation: Late LINEUPS are denied, and the ALLIANCE'S most recent LINEUP is applied.

If the Head REFEREE is busy, and there is no designee, the ALLIANCE CAPTAIN remains in the Question Box to report the LINEUP.

If no previous LINEUP exists, the ALLIANCE Lead is assigned DRIVER STATION 2, 1st team selected is assigned DRIVER STATION 1, and the 2nd team selected is assigned DRIVER STATION 3. If any of these 3 ROBOTS are unable to play, the ALLIANCE must play the MATCH with only 2 (or even 1) ROBOT(s).

Example: 3 teams, A, B, and C form an ALLIANCE going into the Playoff MATCHES. During one of the Playoff MATCHES, Team C's ROBOT becomes inoperable. The ALLIANCE decides to bring in Team D to replace Team C. Team C repairs their ROBOT and may play in any subsequent Playoff MATCHES replacing Team A, B, or D

If a BACKUP TEAM Coupon is accepted and the LINEUP for the next MATCH is not submitted or it omits the BACKUP TEAM, then the ALLIANCE'S most recent LINEUP is used with the BACKUP TEAM in the position populated by the team for whom they're substituting.

T614 ***For replays, no changing LINEUPS (mostly).** If a MATCH must be replayed due to an ARENA FAULT, the LINEUP for the replayed MATCH is the same as the original MATCH. The sole exception is if, in the opinion of the Head REFEREE, the ARENA FAULT rendered a ROBOT inoperable, in which case the LINEUP can be changed.

Violation: The new LINEUP is denied.

10.6.5 Pit Crews

During the Playoff MATCHES and because of the distance between the FIELD and the pit area, extra team members may be needed to maintain and otherwise assist with the ROBOT between MATCHES. Each team is permitted to have up to 3 additional pit crew members to help with needed ROBOT repairs/maintenance.

10.6.6 Small Event Exceptions

The scheduling algorithm described in section [10.5.2 MATCH Assignment](#) works to minimize teams playing in back-to-back MATCHES. However, at events with fewer than 24 teams, back-to-back plays may occur.

Multi-day events with 24 teams or fewer employ a modified Playoff MATCH format. Instead of 8 ALLIANCES, these events proceed through ALLIANCE SELECTION and the Playoff Tournament with the maximum number of complete 3-team ALLIANCES that can be formed while leaving at least 1 BACKUP TEAM (e.g. a 24-team event creates 7 ALLIANCES, a 20-team event creates 6 ALLIANCES).

$$ALLIANCE\ count = \frac{team\ count - 1\ BACKUP\ TEAM}{3}, rounded\ down$$

The Playoff Bracket remains as shown in [Figure 10-2](#), with any matchup against a non-existent ALLIANCE resulting in a bye (i.e. automatic advancement to the next round). An ALLIANCE assigned a bye-MATCH is invited, though not required, to practice together in a null MATCH (i.e. it has no bearing on the Playoff tournament) during the designated time in the Playoff schedule.

District points for Draft Order Acceptance (per section [11.1.2 ALLIANCE Selection Results](#)) are awarded as if a full set of ALLIANCES was selected (i.e. the 2nd selection of the 3-seed ALLIANCE still receive 3 points regardless of how many ALLIANCES are formed).



11 District Tournaments

Teams advance through the season depending on the events at which they compete: Regional or District. This section details how District teams advance from District qualifying events to their District Championship.

11.1 District Events

District teams are ranked throughout the season based on the points they earn at the first 2 home District events they attend, as well as at their District Championship. Points are awarded to teams as follows:

Table 11-1 District Point Assignment

Category	Points
Qualification Round Performance	$QualificationPoints(R, N, \alpha) = \left[InvERF\left(\frac{N - 2R + 2}{\alpha N}\right) \left(\frac{10}{InvERF\left(\frac{1}{\alpha}\right)}\right) + 12 \right]$ <p>(For a typically sized District event, this will result in a minimum of 4 points being awarded for Qualification round performance. For events of all sizes, a maximum of 22 points will be awarded.)</p>
ALLIANCE CAPTAINS	Equal to 17 minus the ALLIANCE CAPTAIN number (e.g. 14 points for ALLIANCE #3 Captain)
Draft Order Acceptance	Equal to 17 minus the Draft Order Acceptance Number (e.g. 12 points for the team that accepts the fifth draft position, regardless of whether it was delayed per T605 .)
Playoff Advancement	Points awarded based on team participation in individual playoff rounds, and whether or not the ALLIANCE advances. See section 11.1.3 Playoff Performance for details.
Judged Team Awards	10 points for <i>FIRST</i> Impact Award 8 points each for Engineering Inspiration and Rookie All Star Awards 5 points each for all other judged team awards
Team Age	10 points for 2025 rookie teams 5 points for 2024 rookie teams

Points earned at District Championships are multiplied by 3 and then added to points earned at District events, to determine the final season point total for the team.

If there is a tie in the season point total between teams, the higher ranked team will be determined using the following additional sorting criteria:

Table 11-2 District team sort criteria

Order Sort	Criteria
1 st	Total Playoff Performance Points
2 nd	Best Playoff Points at a single event
3 rd	Total ALLIANCE Selection Results Points
4 th	Highest Qualification Round Seed or Draft Order Acceptance (i.e. Highest ALLIANCE Selection points at a single event)
5 th	Total Qualification Round Performance Points
6 th	Highest Individual MATCH Score, regardless of whether that score occurred in a Qualification or Playoff MATCH
7 th	Second highest Individual MATCH Score, regardless of whether that score occurred in a Qualification or Playoff MATCH
8 th	Third highest Individual MATCH Score, regardless of whether that score occurred in a Qualification or Playoff MATCH
9 th	Random Selection

11.1.1 Qualification Round Performance

The calculation of Qualification performance points is done using the equation (an inverse error function) in [Table 11-1](#). The equation utilizes the following variables:

- R – the qualification rank of the team at the event at the conclusion of Qualification MATCHES (as reported by FMS)
- N – the number of *FIRST* Robotics Competition teams participating in the Qualification rounds at the event
- Alpha (α) – a static value (1.07) used to standardize the distribution of points at events

This formula generates an approximately normal distribution of Qualification Round Performance points at an event, based on rank, with most teams getting a moderate number of points, and fewer teams getting the highest or lowest numbers of points available.

[Table 11-3](#) displays sample Qualification Round Performance points for variously ranked teams at a 40-team event. The system will automatically generate the appropriate points for each team based on their rank and the number of teams at the event.

Table 11-3 Sample Qualification Round point assignments

Rank	1	2	3	4	...	19	20	21	...	37	38	39	40
Points	22	21	20	19	...	13	13	12	...	6	6	5	4

11.1.2 ALLIANCE Selection Results

This attribute measures both individual team qualification round seeding performance and recognition by peers.

ALLIANCE CAPTAINS are recognized based on their qualification round seeding rank. This rank is a result of the rules of the game, which typically incorporate several team performance attributes, and are designed to eliminate ties in rank. Non-ALLIANCE CAPTAINS are rewarded based on peer recognition. To be invited to join an ALLIANCE, a team’s peers have decided that the team has attributes that are desirable. Giving points for ALLIANCE selection also supports come-from-behind teams. A team taking several MATCHES to optimize their performance may be recognized as a late bloomer by a top seeded team, even if that performance isn’t reflected in the rankings because of poor performance in early MATCHES. These points also have the potential to recognize teams employing a minority strategy with their ROBOT. Teams with unique or divergent ROBOT capabilities that complement the strengths of other ALLIANCE members may be selected to fill a strategic niche.

Note also that ALLIANCE CAPTAINS are given the same number of points as the team drafted in the same sequence. For example, the third ALLIANCE CAPTAIN gets the same number of points as the third draft. Numerical analysis supports the idea that ALLIANCE CAPTAINS are about as strong in ROBOT performance as equivalently drafted teams. As an additional minor benefit, awarding the same points for ALLIANCE CAPTAINS and equivalent drafts lubricates the acceptance of draft offers between ALLIANCE CAPTAINS, which gives teams out of the top 8 the chance to experience being ALLIANCE CAPTAINS themselves.

11.1.3 Playoff Performance

This attribute measures team performance as part of an ALLIANCE.

Teams that advance to at least MATCH 12 earn Double Elimination (DE) Points per the formula below, where β is defined in [Table 11-4](#).

$$DE\ Points = \frac{\#\ of\ DE\ MATCHES\ in\ which\ ALLIANCE\ won\ \&\ team\ participated}{\#\ of\ DE\ MATCHES\ the\ ALLIANCE\ won} \times \beta$$

Table 11-4 Double Elimination Points, β values

ALLIANCE Finish	β
1 st Place (Winners)	20
2 nd Place (Finalists)	20
3 rd Place (loser of MATCH 13)	13
4 th Place (loser of MATCH 12)	7

In most cases, unless a BACKUP is recruited, a team plays 100% of the DE MATCHES won by their ALLIANCE, thus their DE Points simply equal β . If a team does not play 100% of the DE MATCHES won by their ALLIANCE, their DE Points equal their β value multiplied by the percentage of DE MATCHES won by their ALLIANCE in which that team participated. If the result is not a whole number, the value is rounded up to the nearest integer.

Teams on the winning ALLIANCE are awarded additional Finals Points, which are 5 points for each Finals MATCH won and in which the team participated, up to a maximum of 10 points.

For example, if Team X's ALLIANCE wins the event, but Team X only played in 2 MATCHES won by their ALLIANCE, MATCH 13 and Final 1, Team X's Playoff Performance points are $20 * (1/5) + 5 = 9$ points.

The maximum number of Playoff Performance Points a team can earn is 30 (20 DE points + 10 Finals Points).

11.1.4 Awards

This attribute measures team performance with respect to team awards judged at the event.

The points earned for team awards in this system are not intended to capture the full value of the award to the team winning the award, or to represent the full value of the award to *FIRST*. In many ways, the team's experience in being selected for awards, especially the *FIRST* Impact Award, the Engineering Inspiration Award, and the Rookie All Star Award (which is optional for District Championship events), is beyond measure, and could not be fully captured in its entirety by any points-based system. Points are being assigned to awards in this system only to help teams recognize that *FIRST* continues to be "More than Robots[®]," with the emphasis on our cultural awards, and to assist in elevating award-winning teams above non-award-winning teams in the ranking system.

Teams only get points for team awards judged at the event. If an award is not judged, is not for a team (e.g. the Dean's List Award) or is not judged at the event (e.g. Safety Animation Award, sponsored by UL), no points are earned.

11.1.5 Team Age

This attribute recognizes the difficulty in being a rookie or relatively new team.

Points are awarded to 2024 and 2025 rookie teams in recognition of the unique challenges teams face in those early years, and to increase the chance that they will make it to the District Championship to compete with their ROBOTS. Like our dedicated Rookie awards, these additional points are intended to recognize and motivate newer participants in *FIRST* Robotics Competition. These points are awarded once at the beginning of the season. Rookie year is calculated based on the year in which *FIRST* recognizes the team as a rookie.

11.1.6 Regional Participation

District teams neither earn points for their actions at any Regionals, nor are eligible for any *FIRST* Championship qualifying benefits at that Regional (awards, etc.).

11.2 District Championship Eligibility

A team competing in a District qualifies for their District Championship by meeting 1 of the following criteria:

- A. District *FIRST* Impact Award Winner,
- B. District Ranking (based on total points earned at their first 2 home District events as detailed in section [11.1 District Events](#)),

Teams do not earn points at third or subsequent District events, nor at any inter-district or Regional events at which they compete during the season.

If a team declines an invitation to the District Championship, the next highest uninvited team on the list is invited, and so on, until the event capacity is filled.

- C. District Engineering Inspiration winner (qualifies to compete for the award only), and
- D. District Rookie All Star winner (qualifies to compete for the award only).

The capacity of each District Championship is shown in [Table 11-5](#). Each District determines the number of teams that qualify for their District Championship. These limits are based on factors including but not limited to the total number of teams in the District, available venue capacity, etc.

Table 11-5 2025 District Championship Capacities

District Championship	Capacity	Divisions
FIRST Chesapeake District Championship	54	1
FIRST in Michigan State Championship	160	4
FIRST in Texas District Championship	90	2
FIRST Indiana State Championship	38	1
FIRST Israel District Championship	45	1
FIRST Mid-Atlantic District Championship	60	1
FIRST North Carolina State Championship	40	1
FIRST Ontario Provincial Championship	100	2
FIRST South Carolina State Championship	35	1
New England District Championship	96	2
Pacific Northwest District Championship	45	1
Peachtree District State Championship	50	1

11.3 District Championships with Multiple Divisions

If a District Championship has too many teams to allow all teams 12 Qualification MATCHES, then the event hosts multiple divisions. These events have 2 or 4 divisions (based on the number of teams participating, see [Table 11-5](#)) with approximately 40–60 teams in each division. Teams are assigned divisions by FIRST using a process developed by FIRST in Michigan and balances need for accessible seating between Divisions.

The process employs a “brute force iterative randomizer” and is executed as follows:

1. The district team list is sorted in order of cumulative district points earned as described in section [11.1 District Events](#).
2. The list is divided into quartiles based on rank (e.g. the first quartile has the top 25% ranked teams).
3. Division assignments are randomly generated using equal contributions from each quartile.
4. 3 criteria are calculated for each division:
 - a. average strength: the arithmetic mean of the district point values of teams in a division
 - b. distribution of strength: the Signal to Noise Ratio (SNR) of the district point values of teams in a division. SNR is calculated as follows:

$$SNR = 10 \left(\log \frac{\bar{x}^2}{\sigma^2} \right)$$

\bar{x} = arithmetic mean of the district points in a division

σ = standard deviation of the district points in a division

- c. distribution of strength for “top” teams: The SNR of the district point values of teams in the first quartile of a division
- 5. The 3 criteria for each division are compared to the other division(s). If the difference between the division’s value and any other division’s value exceeds the limits in [Table 11-6](#), the criteria is not met.

Table 11-6 District Championship division evaluation limits

	2 divisions	4 divisions
Average strength	1	2
Distribution of strength	1	2.5
Distribution of strength for “top” teams	1.5	2

- 6. If all 3 criteria met, event organizers publish the assignments. If any of the 3 criteria are not met, assignments are rejected, and the process returns to Step 3.

11.4 District Championship Playoffs

In these cases:

- Division winning ALLIANCES play each other in District Championship Playoffs, employing the brackets shown in [Figure 11-1](#) and [Figure 11-2](#) (and detailed in [Table 11-7](#)) that corresponds to their District, until a winning ALLIANCE for the event is determined.

Figure 11-1 4-division District Championship Playoff Bracket

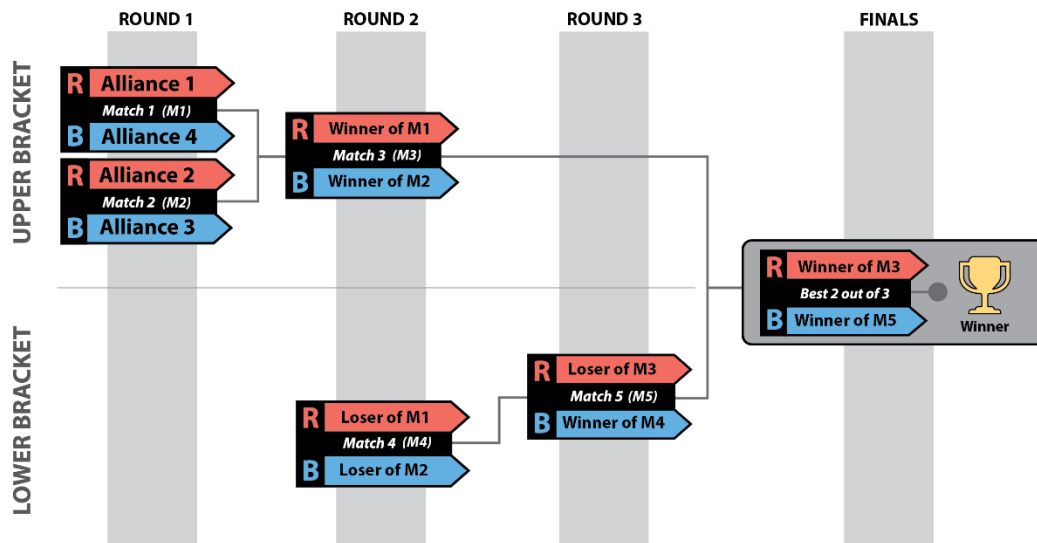

Figure 11-2 2-division District Championship Playoff Bracket

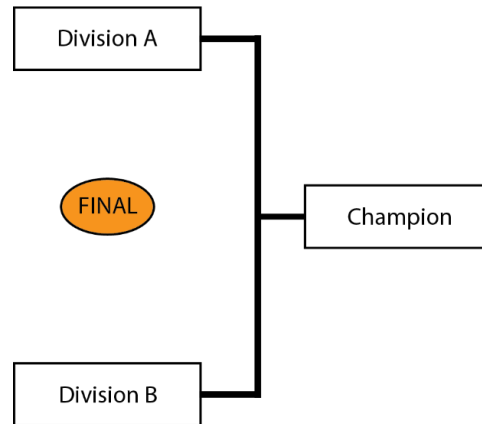

Table 11-7 District Championship 4-ALLIANCE Playoff MATCH schedule

Round	MATCH	Upper/ Lower	Gap (min)				Next MATCH (MATCH # (ALLIANCE color))	
			Blue	Red	Blue	Red	Winner	Loser
1	1	Upper	B	A			M3 (R)	M4 (R)
	2	Upper	D	C			M3 (B)	M4 (B)
15-minute break								
2	3	Upper	W2	W1	17m	24m	M6 (R)	M5 (R)
	4	Lower	L2	L1	24m	31m	M5 (B)	
15-minute break								
3	5	Lower	W4	L3	17m	24m	M6 (B)	
15-minute break								
Finals	6		W5	W3	17m	44m	M7	M7
15-minute break								
Finals	7		W5	W3	17m	17m	M8*	M8*
15-minute break								
Finals	8*		W5	W3	17m	17m		

* if required

- Each team on a Champion ALLIANCE of a 2-Division District Championship Playoff tournament earns 10 points.
- For a 4-Division District Championship Playoff tournament, each team on a Champion ALLIANCE earns 20 points and each team on a Finalist ALLIANCE receives 10 points.
- If any of these ALLIANCES has recruited a BACKUP TEAM, these points are divided amongst the teams as described in section [11.1.3 Playoff Performance](#).

- If an ALLIANCE in a District Championship Playoff has not yet recruited a BACKUP TEAM per section [10.6.3 BACKUP TEAMS](#), the ALLIANCE CAPTAIN may bring in only the highest ranked team from their division's BACKUP POOL to join its ALLIANCE.

11.5 FIRST Championship Eligibility

Each District determines the number of Dean's List Finalists, FIRST Impact Awards, Rookie All Star Awards, and Engineering Inspiration Awards to present at their District Championship, within a range established by FIRST. The team counts are based on the team representation of the respective District at the Championship. For the awards, ranges are developed by using ratios agreed upon by FIRST and District Leadership. These ranges allow each District to represent their own community as they see fit.

- For the FIRST Impact Award, the ratios range from one FIRST Impact Award team for every 18 Championship District teams to one FIRST Impact Award team for every nine Championship District teams.
- For the Dean's List Finalist Award, the ratios range from one Dean's List Finalist for every nine Championship District teams to one Dean's List Finalist for every six Championship District teams.
- All Districts, regardless of FIRST Championship Slot allocation, may award one or two Engineering Inspiration and Rookie All-Star Awards.

The following teams competing in the District model earn a Merit-Based Qualifying slot:

- District Championship
 - FIRST Impact Award Winners
 - Engineering Inspiration Award Winners
 - Rookie All-Star Winners (the judges can decide if they present this award or not)
 - Winning Alliance members
- as many teams in District-points total order to fill the Allocated FIRST Championship slots granted per the table below.

Districts receive the percentage of 'available slots' at FIRST Championship, rounded up to the nearest whole slot, equal to the percentage of teams they have in their District compared to the total of all FIRST Robotics Competition teams. 'Available slots' are calculated by taking the total number of slots at FIRST Championship and subtracting the number of pre-qualified teams. This overall calculation uses a 'snapshot' of teams that have registered and paid as of three weeks after initial season payment was due.

Table 11-8 District FIRST Championship and awards allocations

District	Allocated FIRST Championship Slots	FIRST Impact Award Winners	Dean's List Award Finalists	Engineering Inspiration Award Winners	Rookie All-Star Award Winners	Woodie Flowers Award Finalists
FIRST Chesapeake	17	2	3	2	1	2
FIRST in Michigan	80	4	13	1	2	3
FIRST in Texas	28	2	5	2	2	2

District	Allocated <i>FIRST</i> Championship Slots	<i>FIRST</i> Impact Award Winners	Dean's List Award Finalists	Engineering Inspiration Award Winners	Rookie All- Star Award Winners	Woodie Flowers Award Finalists
<i>FIRST</i> Indiana Robotics	12	1	2	1	1	1
<i>FIRST</i> Israel	10	1	2	1	1	1
<i>FIRST</i> Mid- Atlantic	23	3	4	2	1	2
<i>FIRST</i> North Carolina	14	1	2	2	2	1
<i>FIRST</i> South Carolina**	5	1	2	1	1	1
NE <i>FIRST</i>	31	3	5	2	1	2
Ontario	22	2	4	1	1	2
Pacific Northwest	22	2	4	2	1	2
Peachtree	12	1	2	2	1	1

*Due to its size, *FIRST* South Carolina does not have enough Championship slots for this method to work. The following teams will receive automatic invitations to the 2025 *FIRST* Championship from the *FIRST* South Carolina State Championship:

- Winning Alliance Captain
- Winning Alliance First Pick
- *FIRST* Impact Award Winner
- Engineering Inspiration Award Winner
- Next highest District Points



12 Regional Tournaments

Teams advance through the season depending on the events at which they compete: Regional or District. This section details how Regional teams advance from Regional events to *FIRST* Championship.

12.1 Regional Events

Regional teams are ranked throughout the season based on the points they earn at the first 2 Regional events they attend. Points are awarded to teams as follows:

Table 11-1 Regional Point Assignment

Category	Points
Qualification Round Performance	$QualificationPoints(R, N, \alpha) = \left[InvERF\left(\frac{N - 2R + 2}{\alpha N}\right) \left(\frac{10}{InvERF\left(\frac{1}{\alpha}\right)}\right) + 12 \right]$ <p>(For a Regional event, this will result in a minimum of 3 points being awarded for Qualification round performance. For events of all sizes, a maximum of 22 points will be awarded.) See section 11.1.1 Qualification Round Performance for details.</p>
ALLIANCE CAPTAINS	Equal to 17 minus the ALLIANCE CAPTAIN number (e.g. 14 points for ALLIANCE #3 Captain.) See section 11.1.2 ALLIANCE Selection Results for details.
Draft Order Acceptance	Equal to 17 minus the Draft Order Acceptance Number (e.g. 12 points for the team that accepts the fifth draft position, regardless of whether it was delayed per T605 .)
Playoff Advancement	Points awarded based on team participation in individual playoff rounds, and whether or not the ALLIANCE advances. See section 11.1.3 Playoff Performance for details.
Judged Team Awards	45 points for <i>FIRST</i> Impact Award 28 points for Engineering Inspiration Award 8 points for Rookie All Star Award 5 points each for all other judged team awards See section 12.1.1 Awards for full details.
Team Age	10 points for 2025 rookie teams 5 points for 2024 rookie teams See section 12.1.2 Team Age for full details.

If there is a tie in the season point total between teams, the higher ranked team will be determined using the following additional sorting criteria:

Table 11-2 Regional team sort criteria

Order Sort	Criteria
1 st	Best Playoff Points at a single event
2 nd	Highest Qualification Round Seed or Draft Order Acceptance (i.e. Highest ALLIANCE Selection points at a single event)
3 rd	Best Qualification Round Performance Points
4 th	Highest Individual MATCH Score, regardless of whether that score occurred in a Qualification or Playoff MATCH
5 th	Second highest Individual MATCH Score, regardless of whether that score occurred in a Qualification or Playoff MATCH
6 th	Third highest Individual MATCH Score, regardless of whether that score occurred in a Qualification or Playoff MATCH
7 th	Random Selection

12.1.1 Awards

This attribute measures team performance with respect to team awards judged at the event.

Much of what is stated in section [11.1.4 Awards](#) is also relevant to Regional events. Points are assigned to awards to recognize that *FIRST* continues to be “More than Robots®” and to elevate award-winning teams above non-award-winning teams in the ranking system. These points are not intended to capture the true value of these awards as that value is truly immeasurable.

Point values for some culture awards (*FIRST* Impact Award, Engineering Inspiration) are higher for Regional events than District events because Districts reward those teams with slots at an intermediate level of competition: their District Championship. Regional teams do not have an intermediate competition level and *FIRST* wants those teams to have an opportunity to share their stories and celebrate their success outside of their regional event.

12.1.2 Team Age

This attribute recognizes the difficulty in being a rookie or relatively new team.

Much of what is stated in section [11.1.5 Team Age](#) is also relevant to Regional events. Points are awarded to 2024 and 2025 rookie teams. Unlike in the District events where these points are awarded once per season, for Regional events these points are awarded at each event they attend. Awarding these points at every event will assist rookies with earning one of the three per-event qualification slots starting in 2026. Rookie year is calculated based on the year in which *FIRST* recognizes the team as a rookie.

12.2 *FIRST* Championship Eligibility

A team competing in a Regional in 2025 qualifies for the *FIRST* Championship by meeting 1 of the following criteria:

- A. Regional *FIRST* Impact Award Winner,
- B. Regional Engineering Inspiration Winner,

- C. Winning Alliance: Captain,
- D. Winning Alliance: 1st Pick, or
- E. Invited from the Regional Pool

12.3 Regional Pool

All Regional event teams not already qualified for the *FIRST* Championship are ranked together in the “Regional Pool” based on the points earned from their first two regional events. Beginning after week 2, teams are invited to the *FIRST* Championship weekly from the Regional Pool based on rank. This list helps ensure the top performing teams across events qualify for the *FIRST* Championship and allows for the consideration of performance across multiple events for teams. Awarding points at the first two events, with a projection if a team has only played one event, rewards consistent performance over the season without being punitive to single-event teams.

12.3.1 Single-event team points calculation

If a team has only played one event at the end of the interval, they are awarded second event points using this formula:

$$\text{Second event points} = 0.6 * (\text{first event points}) + 14$$

This model is based on a regression of Event 1 vs Event 2 points in 2023 and 2024. This calculation projects how many points would be earned by the average team who earned X points at their first event. If the result is not a whole number, the value is rounded to the nearest integer.



13 **FIRST Championship Tournament (C)**

At the 2025 *FIRST* Championship presented by BAE Systems, teams are split into 8 divisions. The process used to assign teams to their division is as follows:

1. Teams requesting accessible seating are split amongst the divisions.
2. Rookies are randomized and then assigned sequentially to divisions, skipping a division for each rookie assigned in Step 1 (i.e. a team in Division 1, a team in Division 2, a team in Division 3, a team in Division 4, a team in Division 5, a team in Division 6, a team in Division 7, a team in Division 8, then back to Division 1 again, until Rookies are all assigned to a division).
3. Step 2 is repeated with veteran teams, with additional assignments as necessary to balance the total teams in each division.

Each division plays a standard tournament as described in section [10.5 Qualification MATCHES](#) and section [10.6 Playoff MATCHES](#) to produce the division Champions. Those 8 division Champions proceed to the Championship Playoffs, on the Einstein FIELDS, to determine the 2025 *FIRST* Robotics Competition Championship Winners, per section [13.4 FIRST Championship Playoffs](#).

13.1 Advancement to the *FIRST* Championship

Details on how teams earn eligibility to attend the *FIRST* Championship can be found in section [11.5 FIRST Championship Eligibility](#) and section [12.2 FIRST Championship Eligibility](#). Teams that are pre-qualified can be found on the [FIRST Championship eligibility webpage](#).

13.2 4-ROBOT ALLIANCES

There is no provision for BACKUP TEAMS at the *FIRST* Championship.

Instead, before each division Playoff Tournament, ALLIANCES are selected per the process as described in section [10.6.1 ALLIANCE Selection Process](#), however the process continues with a third round of selection as follows.

Round 3: The same method is used for each ALLIANCE CAPTAIN'S third choice except the selection order is reversed again, with ALLIANCE 1 picking first and ALLIANCE 8 picking last. This process results in 8 ALLIANCES of 4 teams each.

ALLIANCES may start with any 3 of the 4 ROBOTS on their ALLIANCE during division Playoff MATCHES and during the Championship Playoffs. ALLIANCES submit LINEUPS for their MATCHES as described in section [10.6.4 LINEUPS](#).

13.3 *FIRST* Championship Pit Crews

FIRST distributes buttons to the ALLIANCE CAPTAINS during the ALLIANCE CAPTAIN meeting, which takes place on the division FIELDS. These buttons provide the necessary access to the ARENA for pit crew members.

C301 *Wear your buttons. Only team members wearing proper buttons are allowed on the ARENA floor during division and Playoff MATCHES.

Violation: MATCH won't start until the situation is corrected. Those not displaying identification must leave the ARENA.

Teams should assume they may be chosen for an ALLIANCE and think about the logistics of button distribution and set a plan prior to the ALLIANCE selection

process. It is each ALLIANCE CAPTAIN'S responsibility to distribute buttons to their pit crew members.

13.4 FIRST Championship Playoffs

The 8 division Champions play a Double Elimination style tournament as described in section [10.6 Playoff MATCHES](#) to determine the 2025 FIRST Robotics Competition Champions. Exact MATCH timing is provided to FIRST Championship Playoff teams. ALLIANCES are paired as shown in [Figure 13-1](#).

Figure 13-1 FIRST Championship playoff bracket

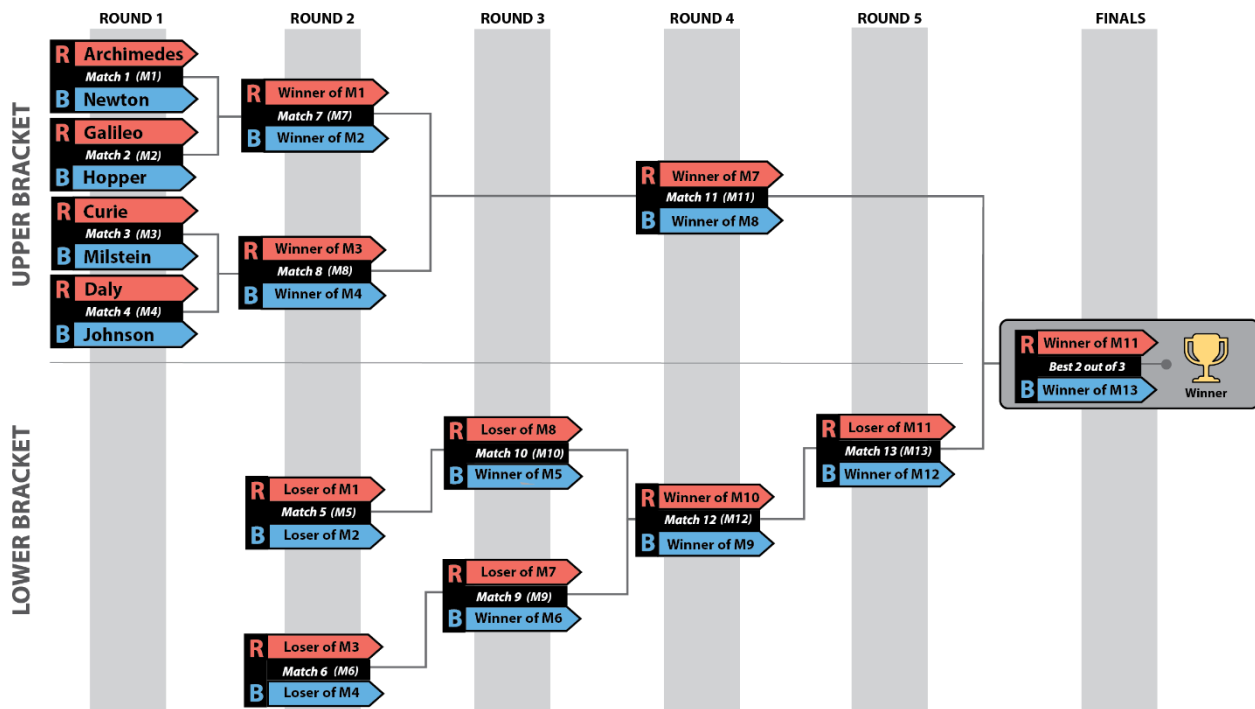

During the Einstein Finals, if the MATCH score of each ALLIANCE is equal, the MATCH is replayed. In this circumstance, the LINEUP may be changed.



14 Event Rules (E)

FIRST is committed to Equity, Diversity, and Inclusion and as such, FIRST strives to make reasonable accommodations for persons with disabilities that request accommodation. If a participant needs an accommodation for an event, please talk to a volunteer at the event or contact your local leadership before the event so they can help ensure the accommodation is provided. Local leadership may make exceptions to event rules to allow for reasonable accommodations given the exceptions do not create an undue hardship or cause safety concerns.

Rules around safety and security within this section are minimum requirements, and Program Delivery Partners are able to implement increased restrictions due to local or venue requirements (e.g. requiring badging for all attendees, reserving seating for accessibility, etc.). Partners should communicate additional local requirements early enough to allow teams to plan.

Safety is always paramount, and many rules are intended to establish norms at each event that will mitigate injury risk to all participants.

Event staff have the final decision authority for all safety-related issues within a venue.

14.1 General Rules

The rules below apply throughout an event, i.e. from when Load-In begins to when Load-Out is complete.

Universal Violation Note: A violation of any Event Rule will result in a VERBAL WARNING. Egregious or subsequent violations will be addressed by the Head REFEREE, the Lead Robot INSPECTOR (LRI) and/or Event Management. Teams should note that egregious and frequent violations may be shared with the Judge Advisor which could lead to disqualification from awards.

Additional rule specific violations, if applicable, are listed with their corresponding rule.

E101 ***Personal safety comes first.** All team members must observe the following safety practices throughout the event:

- A. wear safety glasses (only ANSI-approved, UL Listed, CE EN166 rated, AS/NZS certified, or CSA rated non-shaded) while in and around the playing FIELD and in the pit area. Lightly tinted lenses are permitted provided eyes are clearly visible to others, but reflective lenses are prohibited. Accommodations will be made for participants that require tinted safety glasses. The only exception is for teams in their first 10 minutes of their load in and for the first 10 minutes pits are open each day of the event as long as they're not working on the ROBOT or setting up their pit.
- B. wear closed toed/heeled shoes.
- C. tie back long hair while working on or around a ROBOT or ROBOT related materials.
- D. wear appropriate clothing.
- E. walk in the venue.
- F. health and safety requirements in place for that event (e.g. mask wearing).

For more information about safety at FIRST Robotics Competition events, please reference the [Safety Manual](#).

E102 ***Be nice.** All participants must be gracious and professional at all times while attending FIRST Robotics Competition events. Uncivil behavior toward any participants is not tolerated.

Examples of inappropriate behavior include, but are not limited to

- A. use of offensive language or other uncivil conduct,
- B. intentionally blocking the view of other participants or spectators for an extended period (team members momentarily holding up team signs while directly supporting their team is not considered a violation of this rule.), and
- C. jamming or interfering with the remote sensing capabilities of a ROBOT or the FIELD while in open-access spectator seating areas.

Examples of remote sensing capabilities include, but are not limited to, vision systems, acoustic range finders, sonars, and infrared proximity sensors.

Use of imagery that, to a reasonably astute observer, mimics the AprilTags employed on the FIELD is a violation of this rule.

Examples of particularly contemptible behavior that may result in ejection from the event include, but are not limited to, the following:

- A. assault, e.g. throwing something that hits another person (even if unintended),
- B. threat, e.g. saying something like “if you don’t reverse that call, I’ll make you regret it,”
- C. harassment, e.g. badgering someone with no new information after a decision’s been made or a question’s been answered,
- D. bullying, e.g. using body or verbal language to cause another person to feel inadequate,
- E. insulting, e.g. telling someone they don’t deserve to be on a team,
- F. swearing at another person (versus swearing under one’s breath or at oneself), and
- G. yelling at another person(s) in anger or frustration.

Use of imagery that, to a reasonably astute observer, mimics the AprilTags employed on the FIELD is a violation of this rule.

- E103** ***Children with adults, please.** Children under 12 must be accompanied in the pits by an adult at all times.
- E104** ***Respect the venue.** Teams may not damage the venue, including but not limited to bleachers, floors, walls, railings, etc., in any way.
- E105** ***Teams must check in.** An adult team member must check in at the Pit Administration station no later than 90 minutes before Qualification MATCHES are scheduled to start.

Violation: Teams will be contacted in their pit. Failure to Check-In may result in a team not participating in the event.

Event check-in takes place at the Pit Administration station the evening before and/or the first morning of each event.

Once a team’s consent and release forms are submitted at Pit Administration, each team will receive their DRIVE TEAM & Safety Captain buttons.

- E106** ***Some event resources for event teams only.** Only teams registered for an event may use that event’s Competition FIELD, Practice Field, Spare Parts, Machine Shop, and Inspection. Host teams supplying Practice Field elements and/or Machine Shop resources may use them, however teams registered for that event must be granted priority.

- E107 *Work in designated areas only.** At the event venue, teams may only produce FABRICATED ITEMS as follows:
- A. in their pit area,
 - B. in another team's pit area with permission from that team,
 - C. while queued for a MATCH or Practice Field (given space constraints, extra scrutiny regarding safety is required),
 - D. any area designated by Event Staff (e.g. Playoff Pit Area, etc.), or
 - E. as permitted at provided machine shops that are available to all teams.
- E108 *Some things don't belong at events.** Do not bring or use the following:
- A. skateboards
 - B. 'hoverboards'
 - C. drones
 - D. bottled gas tanks (e.g. helium)
 - E. noisy devices or noisemakers, such as floor stompers, whistles and/or air horns
 - F. walkie-talkies
 - G. scooters, except for those used for accommodations
- E109 *Don't arrange for additional utilities.** Do not arrange for power, internet access, or phone lines from venue service providers or attempt to use venue internet connections reserved for event purposes (e.g. the FIELD Management System or web casting).
- E110 *Don't sell stuff.** Teams may not conduct sales at an event. This includes, but is not limited to, raffle tickets, food, hats, shirts, candy, water, soft drinks, fruit, or any promotional products.
- E111 *Don't give out food.** Teams may not distribute food to others at an event.
- E112 *Make FIRST loud, but with restrictions.** Do not invite or bring live bands to play in the audience. Do not play loud music.
- E113 *Hang banners with care.** Be respectful when hanging your banners.
- A. Do not cover or move other team or sponsor signs already in place.
 - B. Share the available space fairly with other teams.
 - C. Do not obstruct the view of spectators.
 - D. Get permission from the Event Coordinator before hanging banners outside of your pit.
 - E. Hang signs and banners in a safe manner.
 - F. Banners hung outside team pits must not be larger than 25 ft.² (2.3 m²).
- We encourage teams to bring team flags and/or signs for display in their pits and/or the playing FIELD area.

To find your Event Coordinator, inquire at the Pit Administration desk.

Respect venue-specific rules regarding sign location and hanging methods. At the end of the event, safely remove all signs and anything used to hang the signs (tape, string, etc.).
- E114 *Limit flag and flagpole size.** Flags and flagpoles may not be of unreasonable size and weight.

As a guideline, reasonable flags are less than 3 ft. by 5 ft. (~91 cm by 152 cm) in size and weigh less than 2 lbs. (~907g). Reasonable flagpoles may not be more than 8 ft. (~243 cm) long and weigh less than 3 lbs. (~1360g).

E115 ***No firearms.** Firearms are prohibited at all *FIRST* events for all *FIRST* programs, including without limitation, [all official FIRST Events posted here](#). This policy does not apply to law enforcement or venue security personnel.

E116 ***Only COTS batteries allowed.** Teams may only bring COTS batteries to events. Output wires or connectors may be modified as long as no safety systems are compromised.

Violation: Teams will be asked to remove or not bring in the batteries.

E117 ***Enter only 1 ROBOT.** Each registered *FIRST* Robotics Competition team may enter only 1 ROBOT (or “robot,” a ROBOT-like assembly equipped with most of its drive base, i.e. its MAJOR MECHANISM that enables it to move around a FIELD) into a 2025 *FIRST* Robotics Competition Event.

“Entering” a ROBOT (or robot) into a *FIRST* Robotics Competition means bringing it to or using it at the event such that it’s an aid to your team (e.g. for spare parts, judging material, or for practice).

While “most of its drive base” is a subjective assessment, for the purposes of this rule, an assembly whose drive base is missing all wheels/treads, gearboxes, and belts/chains is not considered a “ROBOT.” If any of those COMPONENTS are incorporated, the assembly is now considered a “ROBOT.”

This rule does not prohibit teams from bringing in ROBOTS from other *FIRST* programs for the purposes of awards presentations or pit displays.

14.2 Machine Shops

Some events host a machine shop, open during specific hours (see the event’s agenda), to help teams with repair and fabrication of their ROBOT. Machine shops are typically sponsored by NASA or local organizations. While the machine shops vary, *FIRST* strives to have welding and a variety of high-powered tools available at all events.

In most cases, the machine shop is on site and readily accessible to all teams. If a team attends an event where the Machine Shop is off-site, volunteers are in place to transport the ROBOT or parts to and from the machine shop. In this case, a team fills out a Machine Shop Request Form that travels with the ROBOT or parts, so the machine shop staff and volunteers can follow their directions. The event should set up a method of communication between the venue and off-site machine shop in case there are any questions.

E201 ***The ROBOT goes alone to off-site machine shops.** Team members may not travel to off-site machine shops with the ROBOT being transported by volunteers.

Teams may travel to the off-site machine shop on their own, either by walking or using their own vehicle, but all STUDENT team members must be accompanied by an adult at all times. Teams should strongly consider including a third team member per [the FIRST Youth Protection Program guidelines](#).

14.3 Wireless Rules

E301 *No wireless communication. Teams may not set up their own 802.11a/b/g/n/ac/ax/be wireless communication (e.g. access points or ad-hoc networks) in the venue.

A wireless hot spot created by a cellular device, camera, smart TV, etc. is considered an access point.

Some smart TVs have access points enabled by factory default. Please make sure that functionality is disabled for any TVs brought to the event.

E302 *Don't interfere with wireless networks. Participants may not interfere, attempt to interfere, or attempt to connect with any other team or *FIRST* wireless communication except as expressly allowed for purposes of communicating with their team's ROBOT on the FIELD or Practice Field.

Teams are encouraged to report suspected wireless security vulnerabilities to the *FIRST* Technical Advisor (FTA) if at the event or to *FIRST* via customerservice@firstinspires.org.

Violation: Subsequent violations may lead to dismissal from event and/or legal action based on applicable laws.

E303 *Tethered operation outside FIELDS/Practice Fields. ROBOTS may only be operated by tether when outside the FIELD or Practice Field.

14.4 Load-In

Events set specific time frames, published on the event's schedule, in which teams are invited to load their ROBOT and equipment into their pit areas before pits officially open.

Load-In can be stressful for teams and volunteers, which can be mitigated by preparation and planning. Unanticipated factors, like traffic or weather, can change a team's scheduled arrival time, making the process difficult. The most important things a team should remember are to be safe, gracious, and professional. Teams who experience smooth and easy Load-Ins are encouraged to check with others to see if they can help and make their experience as positive as possible.

E401 *Load in during Load-In. Teams may not bring the ROBOT or ROBOT elements into the event after the designated Load-In period. Exceptions are as follows:

- A. exceptions listed in [R302](#)
- B. raw stock
- C. COTS items
- D. gearboxes attached to associated motor(s)
- E. assembled wheels
- F. exceptional circumstances that result in a team not being able to make the Load-In time and has made arrangements with Event Management.

There are no rules that explicitly restrict items that may be brought into the venue during the designated Load-In period.

If an event does not have a designated Load-In period on its Public Schedule, the designated Load-In period begins when pits open and ends when opening ceremonies start.

During Load-In, teams are not limited to a single trip, and are encouraged to be as efficient and safe as possible.

Violation: Item will not be permitted into venue.

E402 *Load-In person limit is 5. Only 5 team members (one of which must be an adult) may be in the pit area during any Load-In period prior to pits opening.

Violation: Extra team members must leave the venue.

E403 *Load-In Restrictions. The only team permitted activities during load in are:

- A. bringing materials into their pit area.
- B. ROBOT and BUMPER weighing (if available at your event), including any necessary BUMPER installation or removal
- C. Early Pit Setup (if available at your event)

Violation: Teams will be asked to leave the pit area.

E404 *Pit must be left in a safe state. Teams must have their pits in a safe state by the time pits close (even if some tasks are left undone).

E405 *Once done, head out. Unless assisting other teams per the introductory language in this section, teams must leave the venue once finished delivering materials (or, in the case of Early Pit Setup, when setup is complete).

If an event has designated Early Pit Setup times both the evening before and the morning before pits officially open, a team may use both periods for Load-In and setup, but per this rule must leave once pit setup is complete.

Violation: Teams will be asked to leave the pit area.

14.5 Pits

A team pit is the designated space, usually 10 ft. by 10 ft. by 10 ft. (~3 m x 3 m x 3 m), where a team may work on their ROBOT. Each team is assigned a pit space marked with their team number. This helps team members, judges, and visitors find teams easily. Each team pit has a table and power outlet.

Teams, volunteers, *FIRST* staff, and guests spend a lot of time in the pits. Get to know other teams and help each other when you can. Time is short and help is very often right "next door" in the adjacent team pits.

Small, bench-top machinery, with appropriate guards, is permitted in team pits. 'Small' machinery is machinery that can be easily lifted by one person and examples include, but are not limited to, small band saws, drill presses, desktop CNC mills, and sanders.

E501 *Pits are unavailable if closed. Teams may not be in their team pit outside the designated pit hours.

E502 *Stay in your pit. Teams may neither allow their materials to expand beyond their team pit (including running power or internet lines from their team pit to any other area), swap team pits with other teams, nor move themselves to empty team pits.

E503 *Keep aisles clear. Aisles must be kept clear.

E504 *No sparks. Tools that throw sparks or produce open flames are prohibited.

Examples of tools that violate this rule include, but are not limited to, welders, bench and angle grinders, gas torches, etc.

E505 *Nothing too big. Floor standing power tools are prohibited.

Examples include but are not limited to full-size drill presses, band saws, and table saws.

Violation: Teams will be asked to remove or not bring in floor standing power tools. Any items that are deemed unsafe or outside specifications by FIRST personnel, event management, and/or local committee members must be removed.

E506 ***No brazing or welding.** Brazing/welding is prohibited.

Violation: Teams will be asked to remove or not bring in brazing/welding tools. Any items that are deemed unsafe or outside specifications by FIRST personnel, event management, and/or local committee members must be removed.

E507 ***Solder with specific tools only.** Soldering may be done using an electric iron/gun only.

Violation: Any items that are deemed unsafe or outside specifications by FIRST personnel, event management, and/or local committee members must be removed.

E508 ***Structures must be safe.** Teams may not build any structure that supports people or stores items overhead.

Violation: Any pit structures that is deemed unsafe or outside specifications by FIRST personnel, event management, and/or local committee members must be removed.

E509 ***Secure team identification assets.** Team signs, flags, and displays must be securely mounted to the pit structure.

Violation: Any pit structures that is deemed unsafe or outside specifications by FIRST personnel, event management, and/or local committee members must be removed.

14.6 Practice Areas

FIRST Robotics Competition Practice Areas are intended to allow teams to interact with representative FIELD elements and to test their starting AUTO modes, they are not designed for multiple SCORING ELEMENT autonomous modes or full field play. Although some Practice Fields may provide more space for additional strategy development, ample space for long full FIELD interaction should not be expected. FIRST provides a recommended layout, but events may need to tweak exact placement depending on the space available in the venue.

Practice Fields are tether-only except for some District Championships and FIRST Championship which may choose to run a full Field Management System on a Practice Field. For events that have full FIELDS but are using tether, teams should expect that 2 teams are allowed on half the field at a time. Practice Field Attendants may allow additional teams provided teams are a safe distance from one another.

Teams are also expected to provide and place their own AprilTags if they would like to use them. Printable copies of the field AprilTags can be found on the [2025 Playing FIELD webpage](#).

E601 ***Inspection for Practice Fields.** A team may only use the designated event practice areas with a ROBOT that has passed an initial, complete inspection.

E602 ***Practice only when/where permitted.** Teams may only practice with their ROBOT in their pit space, in the designated event practice areas, or while in a Practice MATCH.

Teams may not set up their own practice equipment outside their pit. When practicing in their pit, safety must remain the top priority. If Event Management determines a pit practice setup is unsafe or interferes with activity in adjacent pits or aisles, the team must discontinue the activity.

E603 **Practice Field attendance is limited.** Only team members actively working on the ROBOT are allowed to be on the Practice Field.

The intent of this rule is to limit the number of people directly next to ROBOTS that are enabled. The recommendation is no more than 5 members per team, but some events may limit further due to available space.

Teams may have additional team members watching from a distance, provided the venue has space, but those members should be a safe distance from all ROBOTS operating at the Practice Field.

E604 Give ROBOTS space. When using a tether on Practice Fields, teams must keep a safe distance from all ROBOTS and moving elements and must not interact directly with the ROBOT when it is enabled.

Generally, a safe distance is ~6' (~182 cm) from the ROBOT.

E605 Be ready to DISABLE. Teams must be ready to DISABLE their ROBOT if the ROBOT does not move in the desired direction or in case of safety.

E606 Be safe. [G102](#) and [G103](#) also apply at the Practice Field(s).

Violation: VERBAL WARNING. Practice Field suspension if subsequent violations during the event.

14.7 ROBOT Carts

Most teams use carts to transport their ROBOT throughout an event. Carts are not required but are strongly recommended (to minimize risk of muscle strains, dropped ROBOTS, and other hazards). In addition to the rules listed below, teams are strongly encouraged to put the team's number on the cart, refer to the [FIRST Safety Manual](#) for ROBOT lifting techniques, and practice putting the ROBOT on and off the cart to develop a safe, quick, fluid routine.

E701 *Carts must be safe and easy to use. Carts must be easy to control, maneuver, and pose no risk to bystanders.

E702 *Carts shouldn't be too big. Carts must fit through a standard 30-inch door.

E703 *Carts can't park anywhere. Carts must remain in the team pit (or cart staging area if during a MATCH) when not in use.

E704 *No noisy carts. Carts may not be equipped with music or other sound-generating devices, except for devices of reasonable volume used for safety purposes (e.g. to make others in the vicinity aware that a ROBOT is on the move).

E705 *No motor driven carts. ROBOT carts may not use powered propulsion.

E706 *Small ROBOT carts are allowed on the FIELD. ROBOT carts smaller than 2 ft 6 in. (~76 cm) by 3 ft. (~91 cm) may be brought onto the FIELD to aid in staging and retrieving the ROBOT provided they are not left unattended and do not pose any other safety hazards.

14.8 Ceremonies

At every event, there are Opening and Closing Ceremonies to show honor and respect for represented countries, sponsors, teams, mentors, volunteers, and award winners. Ceremonies provide everyone with the opportunity to collectively applaud the successes of all participants. They also give teams a chance to "meet" the volunteers and other people and sponsors involved with the event. Closing Ceremony elements at the end of the event are integrated into and presented between Playoff Matches.

At the Awards Ceremony, *FIRST* presents trophies and medallions to outstanding teams. All team members are encouraged to attend the ceremonies, be punctual, and show appreciation to volunteers that staffed the event.

- E801** ***If in the pits during Ceremonies, shhhhhh.** During Ceremonies outside of Playoff MATCHES, team members may not:
- A. use power tools
 - B. use loud hand tools (hammers, saws, etc.)
 - C. shout, yell, or use loud voices, unless as a demonstration of approval during a ceremonial activity.
- E802** ***Pit person limit during Ceremonies is 5.** No more than 5 team members may be in the pits during Ceremonies outside of Playoff MATCHES.
- E803** ***Be respectful during anthems.** Team members, including any remaining in the pits, should exhibit peaceful behavior during the presentation of all national anthems. Traditionally, team members stand to face the flag, remove hats, and either sing along or maintain a respectful silence during the anthems of all nations present at the event. If team members wish to abstain, they have a right to do so, as long as they remain silent and non-disruptive.

14.9 In the Stands

- E901** ***No saving seats.** Teams are not permitted to save or designate seats for team members that are not present.

Teams may not hang banners or ribbons or otherwise designate seating. (Event staff will remove and discard any banners, roping, etc., used to designate seating.) Please take turns sitting in the bleachers/stands if seating is limited. If there is a crowding problem, we ask that you kindly leave after your team's MATCH and return later, if possible.

Event management may reserve seats for attendees who require accommodations.

- E902** ***Don't throw items from the stands.** Items may not be thrown from audience seating.



15 Glossary

Term	Definition
ACTIVE DEVICE	any device capable of dynamically controlling and/or converting a source of electrical energy by the application of external electrical stimulus
ALGAE	a 16 in. (41 cm) \pm ½ in. (~12 mm) diameter rubber playground ball.
ALLIANCE	a cooperative of up to 4 <i>FIRST</i> Robotics Competition teams
ALLIANCE AREA	a 18 ft. 1¼ in. wide by 13 ft. 10¾ in. deep (~552 cm by 423 cm) infinitely tall volume formed by, and including the ALLIANCE WALL, CORAL STATION AREAS, the edge of the carpet, and white colored tape
ALLIANCE CAPTAIN	The designated STUDENT representative from each ALLIANCE Lead
ALLIANCE WALL	separates ROBOTS from DRIVE TEAM members in the ALLIANCE AREA
ANCHOR	a collection of surfaces at the top of the CAGE and chain assembly
ARENA	includes all elements of the game infrastructure that are required to play REEFSCAPE SM presented by Haas: the FIELD, SCORING ELEMENTS, queue area, team media area, designated TECHNICIAN area, and all equipment needed for FIELD control, ROBOT control, and scorekeeping
ARENA FAULT	an error in ARENA operation
AUTO	the first 15 seconds of the MATCH, and the FMS blocks any DRIVER control, so ROBOTS operate with only their pre-programmed instructions
BACKUP POOL	the group of teams willing and able to join an ALLIANCE during the Playoff MATCHES, if needed
BACKUP TEAM	The team whose ROBOT and DRIVE TEAM replaces another ROBOT and DRIVE TEAM on an ALLIANCE during the Playoff MATCHES
BARGE	a 29 ft. 2 in. (889 cm) wide, 3 ft. 8 in. (~112 cm) deep, and 8 ft. 5 in. (~257 cm) tall structure that spans the center of the FIELD
BARGE ZONE	a 3 ft. 10 in. deep by 12 ft. 2½ in. long (~117 cm by 372 cm), infinitely tall, 4-sided volume surrounding the ALLIANCE'S half of the BARGE. It is bounded by and includes the ALLIANCE-colored tape.
BRANCH	angled or compound extensions from the REEF vertical pipes.

Term	Definition
BUMPER	a required assembly which attaches to the ROBOT frame. BUMPERS protect ROBOTS from damaging/being damaged by other ROBOTS and FIELD elements.
BUMPER ZONE	a space between 2 ½ in. (~63 mm) and 5 ¾ in. (~146 mm) from the floor.
BYPASSED	a state applied to any ROBOT which is unable or ineligible to participate in that MATCH, as determined by the FTA, LRI, or Head REFEREE
CAGE	2 ft. tall and 7¾ in. wide (outside dimension) (~61 cm tall and ~19 cm wide) rectangular structures suspended from the truss structure in specific locations
CHUTE	55° sloped tunnel that leads to the opening in the CORAL STATION
COACH	a guide or advisor
COMPONENT	any part in its most basic configuration, which cannot be disassembled without damaging or destroying the part or altering its fundamental function
CONTINUOUS	describes durations that are more than approximately 10 seconds
CONTROL	an action by a ROBOT in which a the SCORING ELEMENT is fully supported by or stuck in, on, or under the ROBOT or intentionally pushes a SCORING ELEMENT to a desired location or in a preferred direction (i.e. herding).
CORAL	a 11 ⅞ in. long (~30 cm) piece of 4 in. diameter Schedule 40 Cellular (Foam) Core PVC pipe. CORAL has a 4-in. (~102 mm) inside diameter and a 4½-in. (~11 cm) outside diameter.
CORAL STATION	assembly through which HUMAN PLAYERS feed CORAL into the FIELD
CORAL STATION AREA	a 5 ft. 10⅞ in. wide by 13 ft. 10⅜ in. ft deep (~180 cm by 423 cm) infinitely tall volume bounded by the CORAL STATION, edge of carpet, and ALLIANCE and white colored tape
CORAL MARK	1 of 6 4 in. by 4 in. (~102 mm by 102 mm) "+" marks used to identify placement of CORAL before the MATCH. Marks are made with black tape.
COTS	a standard (i.e. not custom order) part commonly available from a VENDOR for all teams for purchase
CUSTOM CIRCUIT	Any active electrical item that is not an actuator (specified in R501) or core control system item (specified in R710)

Term	Definition
DISABLED	the state in which a ROBOT is commanded to deactivate all outputs, rendering the ROBOT inoperable for the remainder of the MATCH
DISQUALIFIED	the state of a team in which they receive 0 MATCH points and 0 Ranking Points in a Qualification MATCH or causes their ALLIANCE to receive 0 MATCH points in a Playoff MATCH
DRIVE TEAM	a set of up to 5 people from the same <i>FIRST</i> Robotics Competition team responsible for team performance for a specific MATCH
DRIVER	an operator and controller of the ROBOT
DRIVER STATION	1 of 3 assemblies within an ALLIANCE WALL behind which a DRIVE TEAM operates their ROBOT
FABRICATED ITEM	any COMPONENT or MECHANISM that has been altered, built, cast, constructed, concocted, created, cut, heat treated, machined, manufactured, modified, painted, produced, surface coated, or conjured partially or completely into the final form in which it will be used on the ROBOT
FIELD	an approximately 26 ft. 5 in. (~805 cm) by 57 ft. 6 ⁷ / ₈ in. (~1 755 cm) carpeted area bounded by inward facing surfaces of the ALLIANCE WALLS, CORAL STATIONS, PROCESSORS and PROCESSOR openings, and guardrails
FIELD STAFF	the collective group of people working on or near the FIELD responsible for making sure the MATCHES are cycled through efficiently, fairly, safely, and with a spirit of cooperation, Gracious Professionalism, and generosity of spirit
FMS	the FIELD Management System
FTA	<i>FIRST</i> Technical Advisor
HUMAN PLAYER	a SCORING ELEMENT manager
HUMAN STARTING LINE	a white line spanning the ALLIANCE AREA between the CORAL STATION AREAs that is parallel to and located 2 ft. (~61 cm) from the bottom square tube of the ALLIANCE WALL to the near edge of the tape.
INSPECTOR	a person determined by <i>FIRST</i> to accurately and efficiently assess the legality of a given part of a ROBOT
KOP	the Kit of Parts (KOP)
LINEUP	the 3 teams participating in the MATCH and their selected DRIVER STATIONS

Term	Definition
LEAVE	a scoring accomplishment in which a ROBOT must move such that its BUMPERS no longer overlap its ROBOT STARTING LINE at the end of
LRI	the Lead ROBOT INSPECTOR
MAJOR FOUL	a credit of 6 points towards the opponent's MATCH point total
MAJOR MECHANISM	a group of COMPONENTS and/or MECHANISMS assembled together to address at least 1 game challenge: ROBOT movement, SCORING ELEMENT manipulation, FIELD element manipulation, or performance of a scorable task without the assistance of another ROBOT.
MATCH	the 2-minute and 30-second in which a ROBOT is enabled to play REEFSCAPE
MECHANISM	an assembly of COMPONENTS that provide specific functionality on the ROBOT. A MECHANISM can be disassembled (and then reassembled) into individual COMPONENTS without damage to the parts.
MINOR FOUL	a credit of 2 points towards the opponent's MATCH point total
MOMENTARY	describes durations that are fewer than approximately 3 seconds
MXP	myRIO Expansion port, the expansion port on the roboRIO
NET	a goal in which an ALLIANCE scores ALGAE
OPERATOR CONSOLE	the set of COMPONENTS and MECHANISMS used by the DRIVERS and/or HUMAN PLAYERS to relay commands to the ROBOT
PARK	a state in which a ROBOT'S BUMPERS must be partially or completely contained in their BARGE ZONE at the end of the MATCH
PASSIVE CONDUCTOR	any device or circuit whose capability is limited to the conduction and/or static regulation of the electrical energy applied to it (e.g. wire, splices, connectors, printed wiring board, etc.)
PROCESSOR	A goal with a rectangular opening through which ROBOTS score ALGAE which is 2 ft. 4 in. wide (~71 cm), 1 ft. 8 in. tall (~51 cm), and 7 in. (~18 cm) from the carpet
PROCESSOR AREA	a 3 ft. 7 ³ / ₈ in. wide by 7 ft. 6 in. deep (~110 cm by 229 cm) infinitely tall volume formed by, and including, the ALLIANCE colored tape, guardrail, and the PROCESSOR wall.
PCM	Pneumatics Control Module
PDH	Power Distribution Hub
PDP	Power Distribution Panel

Term	Definition
PH	Pneumatic Hub
PIN	an action by a ROBOT that is preventing the movement of an opponent ROBOT by contact, either direct or transitive (such as against a FIELD element)
RED CARD	issued by the Head REFEREE for egregious ROBOT or team member behavior or rule violations which results in a team being DISQUALIFIED for the MATCH.
REEF	1 of 2 5 ft. 5 ½ in. (~166 cm) hexagonal structures with BRANCHES that extend from each side where CORAL are scored
REEF ZONE	an infinitely tall 6-sided, 7 ft. 9½ in. wide (face to face) (~237 cm), volume surrounding the ALLIANCE'S REEF. It is bounded by and includes the ALLIANCE-colored tape.
REFEREE	an official who is certified by <i>FIRST</i> to enforce the rules of REEFSCAPE
REPEATED	describes actions that happen more than once within a MATCH
ROBOT	an electromechanical assembly built by the <i>FIRST</i> Robotics Competition team to play the current season's game and includes all the basic systems required to be an active participant in the game – power, communications, control, BUMPERS, and movement about the FIELD
ROBOT PERIMETER	the part of a ROBOT contained within the BUMPER ZONE and established while in the ROBOT'S STARTING CONFIGURATION, that is comprised of fixed, non-articulated structural elements of the ROBOT
ROBOT STARTING LINE	a black line that spans the width of the FIELD between each REEF and the BARGE. It is positioned such that it is 7 ft. 4 in. (~224 cm) from the REEF.
RP	Ranking Points
RPM	Radio Power Module
RS	Ranking Score
RSL	ROBOT Signal Light
SCORING ELEMENT	a CORAL or an ALGAE
SIGNAL LEVEL	a term used to characterize circuits which draw ≤1A continuous and have a source incapable of delivering >1A, including but not limited to roboRIO non-PWM outputs, CAN signals, PCM/PH Solenoid outputs, VRM 500mA outputs, RPM outputs, and Arduino outputs

Term	Definition
STARTING CONFIGURATION	the physical configuration in which a ROBOT starts a MATCH
STUDENT	a person who has not completed high-school, secondary school, or the comparable level as of September 1 prior to Kickoff
SURROGATE	a team randomly assigned by the FMS to play an extra Qualification MATCH
TECHNICIAN	a resource for ROBOT troubleshooting, setup, and removal from the FIELD
TELEOP	the Teleoperated Period
VENDOR	a legitimate business source for COTS items that satisfies criteria defined in Section 8 ROBOT Construction Rules
VERBAL WARNING	a warning issued by event staff or the Head REFEREE.
VRM	Voltage Regulator Module
YELLOW CARD	issued by the Head REFEREE for egregious ROBOT or team member behavior or rule violations

