

# 2025 VIRTUAL KIT CATALOG

brought to you by **AMD**  
together we advance\_

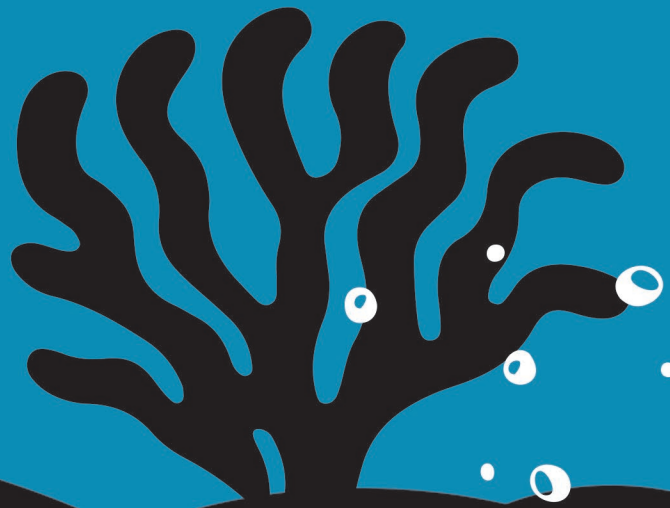

# REEFSCAPE<sup>SM</sup>

PRESENTED BY **HAAS**  
Gene Haas Foundation



**FIRST**  
**ROBOTICS**  
**COMPETITION**

# WELCOME TO THE 2025

## FIRST<sup>®</sup> ROBOTICS COMPETITION SEASON

This Voucher Catalog is a reference for your team. Inside, you'll find additional items and value available to your team via the Kit of Parts system. Each page represents a specific voucher and its particular instructions and details. Don't miss out on any of these opportunities.

**More information about the Kit of Parts can be found at our website:** [firstinspires.org/robotics/frc/kit-of-parts](https://firstinspires.org/robotics/frc/kit-of-parts)

**Questions about the Kit of Parts can be sent to:** [frcparts@firstinspires.org](mailto:frcparts@firstinspires.org)



**We are extremely grateful for the generosity and support that our FIRST<sup>®</sup> Suppliers provide!**

# VOUCHER CHECKLIST

Supplier	Redeemed
Altair .....	<input type="checkbox"/>
Ansys.....	<input type="checkbox"/>
Armatbot .....	<input type="checkbox"/>
Autodesk.....	<input type="checkbox"/>
Automation Direct.....	<input type="checkbox"/>
Clippard .....	<input type="checkbox"/>
DevCycle .....	<input type="checkbox"/>
DigiKey .....	<input type="checkbox"/>
GreenGate3D .....	<input type="checkbox"/>
Mastercam.....	<input type="checkbox"/>
MathWorks .....	<input type="checkbox"/>
monday.com .....	<input type="checkbox"/>
Next Gen Robots.....	<input type="checkbox"/>

Supplier	Redeemed
NI / Emerson .....	<input type="checkbox"/>
OneIPM .....	<input type="checkbox"/>
Plummer Industries .....	<input type="checkbox"/>
REV Robotics .....	<input type="checkbox"/>
RoboPromo.....	<input type="checkbox"/>
SendCutSend .....	<input type="checkbox"/>
SmugMug .....	<input type="checkbox"/>
SOLIDWORKS .....	<input type="checkbox"/>
Swerve Drive Specialties.....	<input type="checkbox"/>
Swyft Robotics .....	<input type="checkbox"/>
Tableau.....	<input type="checkbox"/>
TE Connectivity .....	<input type="checkbox"/>
Vulcan Spring .....	<input type="checkbox"/>



**Organization Name**

**Altair**

**Voucher Detail**

**Altair Software Access**

**Expiration Date**

**12/31/2025**

**Shipping**

**n/a**

**Website**

**[altair.com/first-robotics](https://altair.com/first-robotics)**

Open access to many Altair software apps (via renewable 1-year licenses) for all students and mentors. These apps include, but are not limited to, the following:

**Altair® Inspire™** – for 3D simulation-driven design & engineering using 3D CAD geometry – to simulate whether robots will functionally perform as intended via structural analysis, topology optimization / generative design, and motion dynamics.

**Altair® AI Studio** – (formerly RapidMiner Studio) for code-optional Data Science and AI/ML – especially helpful for rapidly handling, visualizing and analyzing FIRST® team scouting data to select optimal Alliance Partners.

**Altair Compose®** – for extremely easy-to-use equation-based (i.e., 0D) engineering modeling & simulation – like “a calculator on steroids.” Serves as an engineering-oriented complement or alternative to Excel, Python, Java, and/or C++.

**Altair® Twin Activate®** – for open, multi-disciplinary system simulations, especially of electrified/ electro-mechanical devices such as robots. Helpful block-diagram-based (1D) modeling with easy integration with 3D modeling tools.

**Student Edition Bundle** – provides access to many Altair software products, beyond just those listed above, such as **Altair® PSIM™** for modeling & simulating power electronics and power conversion between battery- and-motor systems involving direct current (DC) and alternative current (AC) such as FIRST robots. Could also help with power management.

**Visit Altair’s dedicated page in support of FIRST Robotics teams ([altair.com/first-robotics](https://altair.com/first-robotics)).**

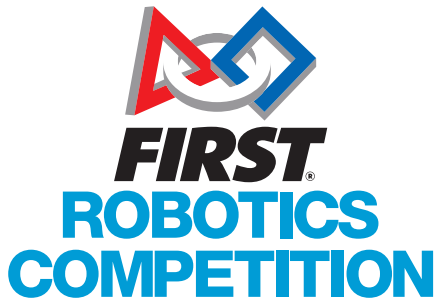



# Build Better Robots, Faster.

Get Your Free Software: [altair.com/first-robotics](https://www.altair.com/first-robotics)



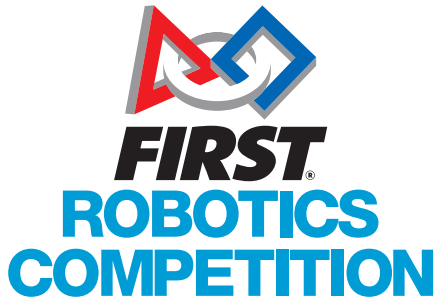

**Organization Name**

**Ansys**

**Voucher Detail**

**Ansys Software Access**

**Expiration Date**

**One year from time of access**

**Shipping**

**n/a**

**Website**

**[ansys.com/student](https://www.ansys.com/student) for free download and [ansys.com/teams](https://www.ansys.com/teams) for full version**

*FIRST*® Robotics teams and mentors can benefit from many Ansys tools. These can be accessed two ways:

**Free Student Downloads:** Please start with these as these are easily accessible to anyone. We don't collect any personal information and software can be downloaded onto your PC. Please note that there are some limits on these versions. Visit [ansys.com/student](https://www.ansys.com/student)

**Full Version Software:** If you are hitting limits and need our full version software, please fill out the "Request Partnership" form found on [ansys.com/teams](https://www.ansys.com/teams)

**Software available to teams includes but is not limited to:**

**Ansys Student:** Workbench-based bundle of design and simulation software including Ansys Mechanical™, Ansys CFD™, Ansys Autodyn™, Ansys Discovery™, Ansys SpaceClaim™, and Ansys DesignXplorer™.

**Ansys SCADE Student:** Unique qualified code-generation technology. It integrates model-based design, simulation and code generation of embedded software.

**Ansys LS-DYNA Student:** Includes a vast array of capabilities using its explicit solver, allowing the simulation of the response of materials to short periods of severe loading and extreme deformation.

**Ansys Electronics Desktop Student:** Includes access to simulation software including Ansys HFSS™, Ansys Maxwell™, Ansys Q3D™, and Ansys Icepack™ allowing design work across a broad range of electrical and electro-mechanical systems.

**Ansys Zemax OpticStudio Student:** Provides extensive materials and optical element libraries, students can accurately simulate real-world scenarios.

**Additional resources include:**

**Ansys Innovation Courses:** For more than 400 open, free courses on using Ansys software visit [ansys.com/courses](https://www.ansys.com/courses)

**Ansys Learning Forum:** For Q&A and support visit [ansys.com/forum](https://www.ansys.com/forum)

The Ansys logo features a stylized 'A' symbol on the left, composed of two parallel diagonal lines forming a triangle, with the leftmost line colored yellow and the rightmost line black. To the right of this symbol, the word 'Ansys' is written in a bold, black, sans-serif typeface.

**Ansys**

# ARMABOT

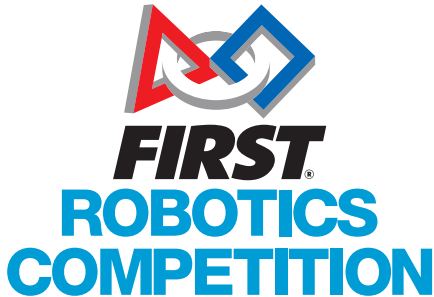

**Organization Name**

**Armabot**

**Voucher Value**

**One (1) RS7 encoder**

**Expiration Date**

**05/01/2025**

**Shipping**

**Team Responsibility**

**Access Code(s)**

**Visit Team Registration Account**

**(Lead Mentor 1 or 2)**

**Website**

**[www.armabot.com](http://www.armabot.com)**

1. Go to [www.armabot.com](http://www.armabot.com)
2. Select 1 or more RS7 encoders (first unit free with this voucher)
3. Enter your valid code from the *FIRST*<sup>®</sup> Team Registration System
4. Enter shipping and billing information
5. Place order and wait for arrival (3-5 days in continental USA)
6. Installation instructions at [www.armabot.com](http://www.armabot.com)
7. Technology tutorial for encoder implementation at [www.armabot.com](http://www.armabot.com)

Valid for purchase of one RS7 encoder individually or a multiple product order that includes one RS7 encoder. Limit one per *FIRST*<sup>®</sup> Robotics Competition Team. Must be registered for the 2025 robotics season. Voucher not transferable to other people or teams.



QUICK INTEGRATION

# Technology Tutorial

CAN bus PID tuning via Talon SRX controller.

EASY INSTALL

## Worm-Drive Clamp

Secure and simple attachment.

COOL RUNNING

## Vented Design

Doesn't interfere with motor air flow.

STRAIN RELIEF

## Secure Wiring

Integrated feature for cable tie.

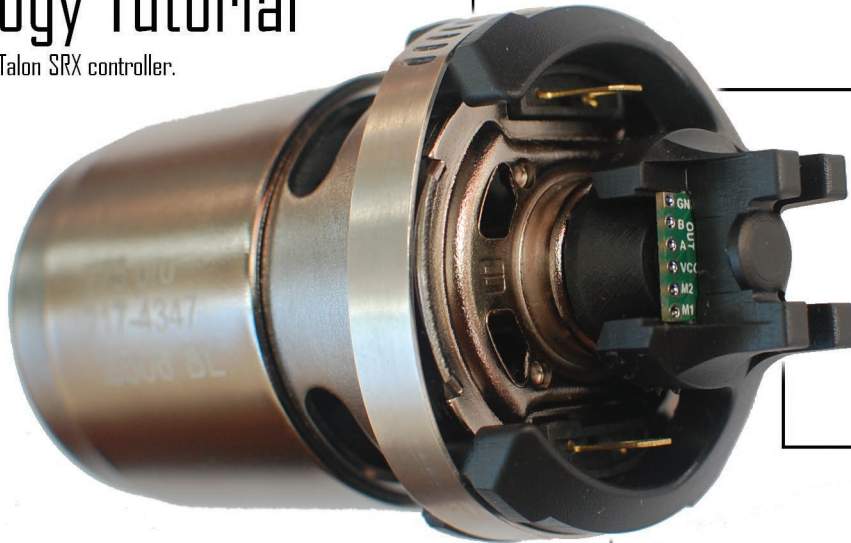

CUSTOM DESIGNED MOUNT

## 775pro Motor Encoder

Successful use at 2016 & 2017 Championships.

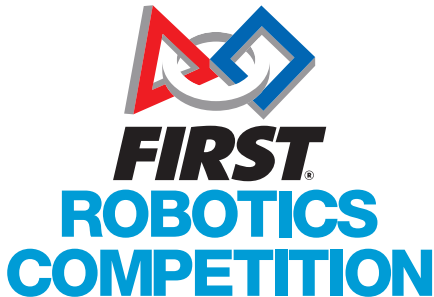

**Organization Name**

**Autodesk**

**Voucher Detail**

**Autodesk Software Access**

**Expiration Date**

**n/a**

**Shipping**

**Included**

**Website**

**[www.autodesk.com/first](http://www.autodesk.com/first)**

**[www.autodesk.com/first](http://www.autodesk.com/first)** is a dedicated page for everything *FIRST*<sup>®</sup> Robotics Competition and Autodesk related, including CAD data sets of the Kit of Parts and playing field, tutorials, and free access to Autodesk software.

**Autodesk<sup>®</sup> Fusion<sup>®</sup>** – Cloud-based CAD, CAM, CAE, and PCB software, enables robot designs, assemblies, photorealistic renderings, fabrication, and team collaboration.

**Autodesk<sup>®</sup> Inventor<sup>®</sup>** – With this professional software, teams can produce 3D models that help with the design and visualization of the robot.

**Synthesis: An Autodesk<sup>®</sup> Technology** – Test your designs for driver practice, robot code emulation, strategy, and more with this robotics simulator.

**Autodesk<sup>®</sup> Tinkercad<sup>®</sup>** – Use Tinkercad Circuits environment to program and simulate an Arduino board for use on your robot.

Autodesk, the Autodesk logo, Fusion, Inventor, and Tinkercad are registered trademarks or trademarks of Autodesk, Inc., and/or its subsidiaries and/or affiliates in the USA and/or other countries. All other brand names, product names, or trademarks belong to their respective holders. Autodesk reserves the right to alter product and services offerings, and specifications and pricing at any time without notice, and is not responsible for typographical or graphical errors that may appear in this document. © 2025 Autodesk, Inc. All rights reserved.

A young woman with long dark hair and black-rimmed glasses is focused on working on a robot's internal wiring. She is wearing a grey t-shirt. The robot's chassis is visible, showing various colored wires (yellow, red, black) and a purple and white striped component. She is using a screwdriver to adjust a part of the wiring.

# Create winning designs

Autodesk is excited to provide open access to our design software, digital fields, and robot part models.

Put your designs to work with our competition simulation software – created specifically for *FIRST*® teams – and get the robot you want on the field faster.

Get started at [www.autodesk.com/first](http://www.autodesk.com/first)



**Organization Name**

**Automation Direct**

**Voucher Description**

**\$50.00**

**Expiration Date**

**08/31/2025**

**Shipping**

**Team Responsibility** (see below for details)

**Access Code(s)**

**Visit Team Registration Account**

(Lead Mentor 1 or 2)

**More Info**

**[www.AutomationDirect.com](http://www.AutomationDirect.com)**

**Use your \$50 voucher toward any items available at [www.AutomationDirect.com](http://www.AutomationDirect.com)**

**IMPORTANT INSTRUCTIONS** - We cannot apply the discount AFTER you place an order!

1. Obtain your voucher code at the Mentor Dashboard at [www.firstinspires.org](http://www.firstinspires.org)
2. Login, OR create a New Account here: [www.automationdirect.com/new-user](http://www.automationdirect.com/new-user)
3. Then visit [www.automationdirect.com/Voucher](http://www.automationdirect.com/Voucher) to enter the voucher code. This will enable a one-time \$50 credit for your account.

**Some Restrictions Apply:**

1. Orders **must** be placed online. No 'call-in' orders.
2. Orders **must** ship to a US or Canadian address. Credit card billing address must also be US or Canadian.
3. The voucher cannot be used towards shipping fees. Orders under \$49 are shipped via 2-day service to US addresses for a flat rate of \$10 (a credit card will be required to pay for shipping). Orders to Canada will incur brokerage fees. Larger orders may qualify for FREE two-day shipping. See website for details: <https://www.automationdirect.com/static/specs/adpolicy.pdf>
4. The voucher cannot be used to pay sales tax. A credit card (or PayPal) will be required to pay any applicable taxes. If your team/organization is tax exempt, you can submit appropriate documentation online during checkout.

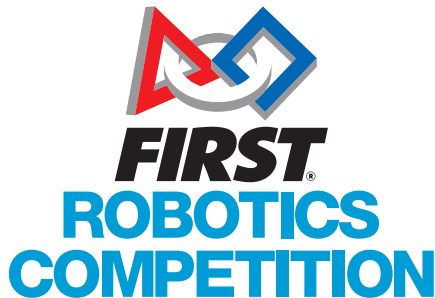

# These items are popular with *FIRST*<sup>®</sup> teams:

Miniature Pneumatic Devices



[go2adc.com/fittings](https://go2adc.com/fittings)

Push connect fittings



[go2adc.com/ptcfittings](https://go2adc.com/ptcfittings)

Pneumatic Cylinders



[go2adc.com/cylinders](https://go2adc.com/cylinders)

Ethernet Cables  
(and crossovers!)



[go2adc.com/cat5e](https://go2adc.com/cat5e)

Belts & Pulleys



[go2adc.com/tbp](https://go2adc.com/tbp)

Wire Ties



[go2adc.com/sapiselco](https://go2adc.com/sapiselco)

Ferrules, Terminals,  
and Crimp Tools



[go2adc.com/zfwire](https://go2adc.com/zfwire)

Sensors and Encoders



[go2adc.com/sensenco](https://go2adc.com/sensenco)



**AUTOMATIONDIRECT**.com

1-800-633-0405 | [www.AutomationDirect.com](http://www.AutomationDirect.com)



# Clippard

Organization Name	Clippard
Voucher Value	\$20.00
Offer Expires	12/31/2025
Shipping	Not Included
Access code	FIRST2025
Website	clippard.com

Congratulations on the many successes you have achieved to earn your team a position in the 2025 *FIRST*® Robotics Competition!

As long-time supporters of the *FIRST*® organization, we are proud to provide you with **\$20.00 of FREE Clippard products** for your design needs. Simply visit [clippard.com](http://clippard.com) to select your products, and use the promotional code above at check out.

*Please note that you must create an account AND be logged in for the voucher to be validated.*

*If you need technical assistance, don't hesitate to contact us at 1-877-245-6247.*

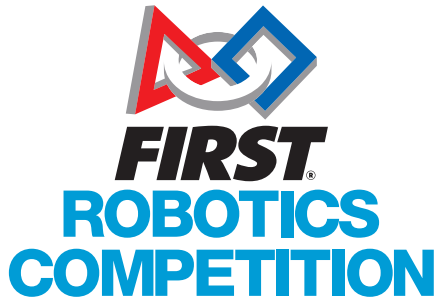

# Clippard



*Pressure Controls • Directional Control Valves • Electronic Valves • Control Valves  
Isolation Valves • Pinch Valves • Manual Valves • Fittings • Air Preparation Equipment  
Tubing • Custom Valves & Assemblies*

**PRECISION FLOW CONTROL  
PRODUCTS & SOLUTIONS**

[www.clippard.com](http://www.clippard.com)



# DevCycle

**Organization Name**

**DevCycle**

**Voucher Value**

**\$120/month platform credit for a Starter Plan**

**Expiration Date**

**12/31/2025**

**Shipping**

**Included**

**Access Code(s)**

**Visit Team Registration Account**  
(Lead Mentor 1 or 2)

**Website**

**<https://devcycle.com/frc>**

*Adding an additional 200,000 MAU, or 2,000,000 experimentation events, or 5,000,000 EdgeDB operations in addition to the free tier!*

1. Sign up for an account at <https://devcycle.com/frc>.
2. Under Settings (<https://app.devcycle.com/r/settings>) - Create an organization with the name being your *FIRST*<sup>®</sup> Robotics Competition Team Number- ie “FRC 9999”
3. Email [frc@devcycle.com](mailto:frc@devcycle.com) with your account email address, *FIRST* Robotics Competition Team Number, Lead Mentor Name, and the PDV Code found on the *FIRST* Robotics Competition Team Registration System to activate your credit!
4. Once confirmed, invite the rest of your team to your organization and start pushing code safely!

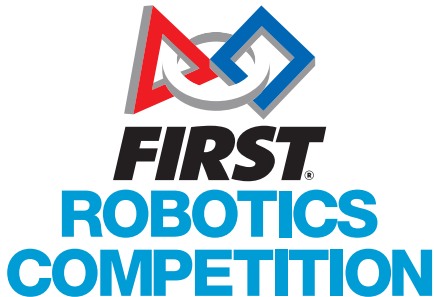





# Dev Cycle

# DigiKey

**Organization Name**

**DigiKey**

**Voucher Value**

**\$65**

**Expiration Date**

**09/30/2025**

**Shipping**

**Included (excludes Marketplace products)**

**Access Code(s)**

**Visit [digikey.com/first](https://www.digikey.com/first) to access your voucher**

**Website**

**[www.digikey.com/first](https://www.digikey.com/first)**

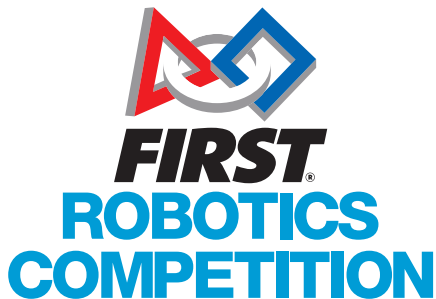

**DigiKey is proud to provide you with \$65 of components.**

- Visit [www.digikey.com/first](https://www.digikey.com/first) to redeem your team's voucher.
- The \$65 voucher will not display on the total of your order, but will be subtracted from your order during processing.
- This Product Donation Voucher valued at \$65 is good for the purchase of components or an XRP specially priced for *FIRST* teams at [www.digikey.com](https://www.digikey.com).

*Taxes not included. This voucher is good for a one time use. Any amount not utilized in your initial transaction will be forfeited.*

# What's the coolest way to spend your free \$65?

We have some suggestions.



**DigiKey**

Find what you need at [digikey.com/first](https://www.digikey.com/first)



GreenGate3D

**Organization Name**

**Voucher Value**

**Offer Expires**

**Shipping**

**Access code**

**Website**

**GreenGate3D**

**\$16.00 discount on select items**

**06/30/2025**

**Team Responsibility\***

**Visit Team Registration Account**

**(Lead Mentor 1 or 2)**

**greengate3d.com**



**FIRST**  
**ROBOTICS**  
**COMPETITION**

**Receive one \$16 discount off of a 1kg spool of virgin or recycled PETG filament, any color.**

It's easy! Go to **greengate3d.com**, pick as many spools as you like, and at checkout (on the right hand side) type in the discount code: **"Good Luck From GreenGate3D"**

*\*As an added bonus, once an order reaches \$60.00, shipping is free!*



GreenGate3D



**Organization Name**

**Mastercam**

**Voucher Value**

**Free annual licenses of the  
Mastercam Educational Suite**

**Expiration Date**

**10/31/2025**

**Shipping**

**Included**

**Access Codes**

**Visit Team Registration Account**

**Website**

**[https://www.mastercam.com/community/competitions/  
first-robotics/](https://www.mastercam.com/community/competitions/first-robotics/)**

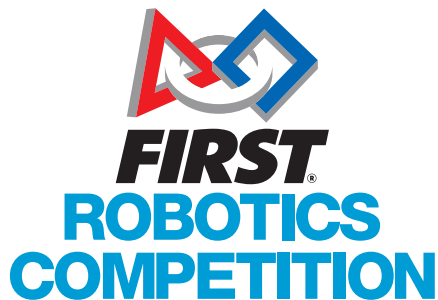

**Mastercam Educational Suite:** Free annual licenses of the current version of the Mastercam Educational Suite. The Mastercam Educational Suite includes Mill, Lathe, Wire, Router, Design, Multiaxis, and Mill-Turn.

Please register your team using the link provided. An email will be sent with your license details.



# **Mastercam**<sup>®</sup>



MILL



MULTIAxis



LATHE



MILL-TURN



WIRE



ROUTER



DESIGN



ADDITIVE



**Organization Name**

**MathWorks**

**Voucher Value**

**MathWorks Resources for *FIRST*® Teams**

**Expiration Date**

**08/31/2025**

**Shipping**

**Included**

**Access Code(s)**

**n/a**

**Website**

**[mathworks.com/first-robotics](https://mathworks.com/first-robotics)**

***MATLAB and Simulink allow students/participants to simulate robots, develop control and navigation algorithms, and optimize their mechanical designs. Please visit our website to request access to MathWorks software as well as find other resources available to *FIRST*® teams:***

- Software license to over 50 products, including:
  - o MATLAB, Simulink, Stateflow, Simscape, MATLAB Coder, Robotics System Toolbox, Navigation Toolbox, Control System Toolbox, Signal Processing Toolbox, Computer Vision Toolbox, Sensor Fusion and Tracking Toolbox and more
- Links to free, 2-hour online courses to get started with MATLAB and Simulink
- Tutorials, videos, and examples for students participating in robotics competitions

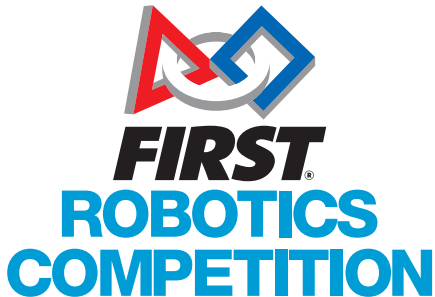



```
if sym =  
  
if sym = 3,  
fa = sym;  
l = sym + 3*(s;  
r j = 2:n;  
alfa(j) = alfa(j)  
l = s-del;
```

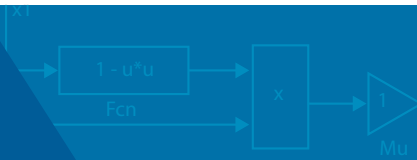

MathWorks creates software tools for students, scientists and engineers to design, simulate, analyze, and optimize dynamic systems such as robots

Learn more at [mathworks.com/solutions/robotics](https://mathworks.com/solutions/robotics)

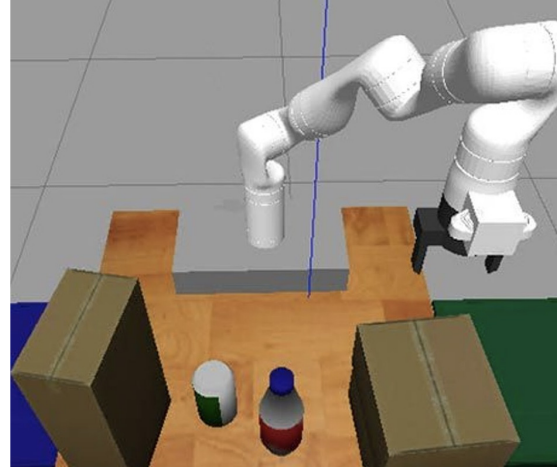
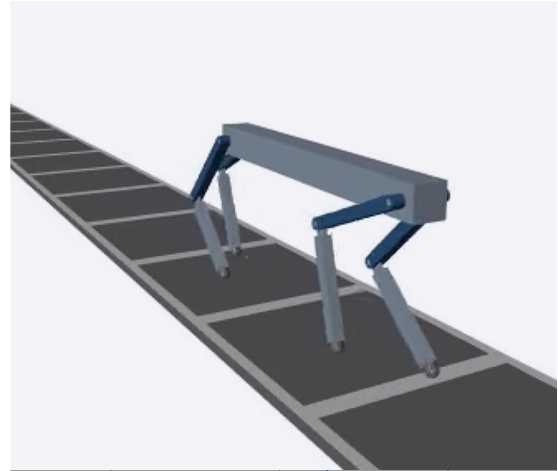



**Organization Name**

**monday.com**

**Voucher Value**

**FREE Pro-level Accounts**

**Expiration Date**

**12/31/25**

**Shipping**

**Included**

**Access Code(s)**

**Visit Team Registration Account**

*(Lead Mentor 1 or 2)*

**Website**

**<https://monday.com/lp/academic/frcglobal>**

*monday.com is pleased to offer free Pro-level accounts to all FIRST® teams.*

monday.com is a work operating system (Work OS) where organizations of any size can create the tools and processes they need to manage every aspect of their work. By combining building blocks, like apps, automations and integrations, teams can build or customize the workflows of their dreams. It's perfect for managing complex projects (like building robots!) and is currently being used by 225,000 customers and hundreds of FIRST teams globally. *This offer has a value of \$16 per user per month.*

*Teams should first create their account on the FIRST Robotics Competition*  
**monday.com page:** <https://monday.com/lp/academic/frcglobal>.

*Then, teams should fill out this short form:*

<https://form.workforms.com/3bLjozj> in order to have the Pro-level features added to their account.

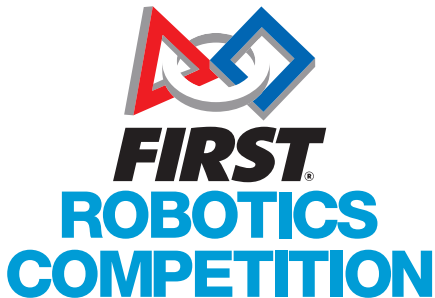



1. Create your team's account at [monday.com/nonprofits](https://monday.com/nonprofits)

All accounts come with a 14-day free trial

2. Scan the QR code to have your team's account added to our **free** FIRST program

Eligible accounts receive 10 **free** seats on each monday.com product, at the pro tier, plus 70% discount on any extra seats

*"Our entire build season and beyond is managed end-to-end using monday.com."*

Team #2231, OnyxTronix



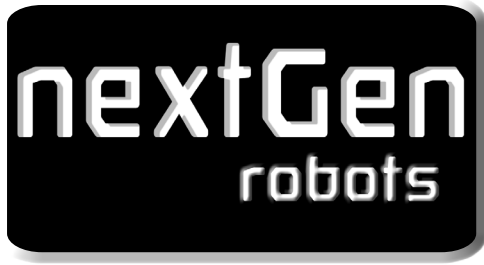

**Organization Name**

**Next Gen Robots**

**Voucher Detail**

**1 CIM Cooler 180 or 775 Cooler 360**

**Expiration Date**

**05/31/2025**

**Shipping**

**Team Responsibility**

**Access Code(s)**

**Visit Team Registration Account**

**(Lead Mentor 1 or 2)**

**Website**

**[www.nextgenrobots.com](http://www.nextgenrobots.com)**

**Attention *FIRST*® Robotics Competition Teams:**

1. Make sure to email [sales@nextgenrobots.com](mailto:sales@nextgenrobots.com) with your Lead Mentor Name, *FIRST* Robotics Competition Team Number, your choice of the 775 Cooler 360 or the CIM Cooler 180, and PDV Code so that we can verify your code is activated before you make your order.
2. Once confirmed, make sure to enter the PDV code into the Coupon Code field when you place your order and the discount should appear during checkout. Do not Check out as Guest.
3. This coupon can be redeemed for one CIM Cooler 180 (an \$8.00 value) or one 775 Cooler 360 (an \$8.00 value) but products can be purchased in any combination and multiple amounts of the CIM Cooler or the 775 Cooler. After applying the coupon code during checkout, the total will be less \$8.00. Before submitting your order make sure the discount has been applied to the total. If the discount does not show, try clicking View Cart and reapply the code.

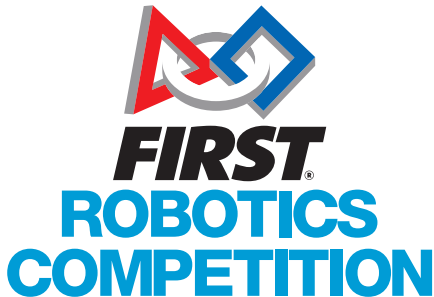

nextGen  
robots

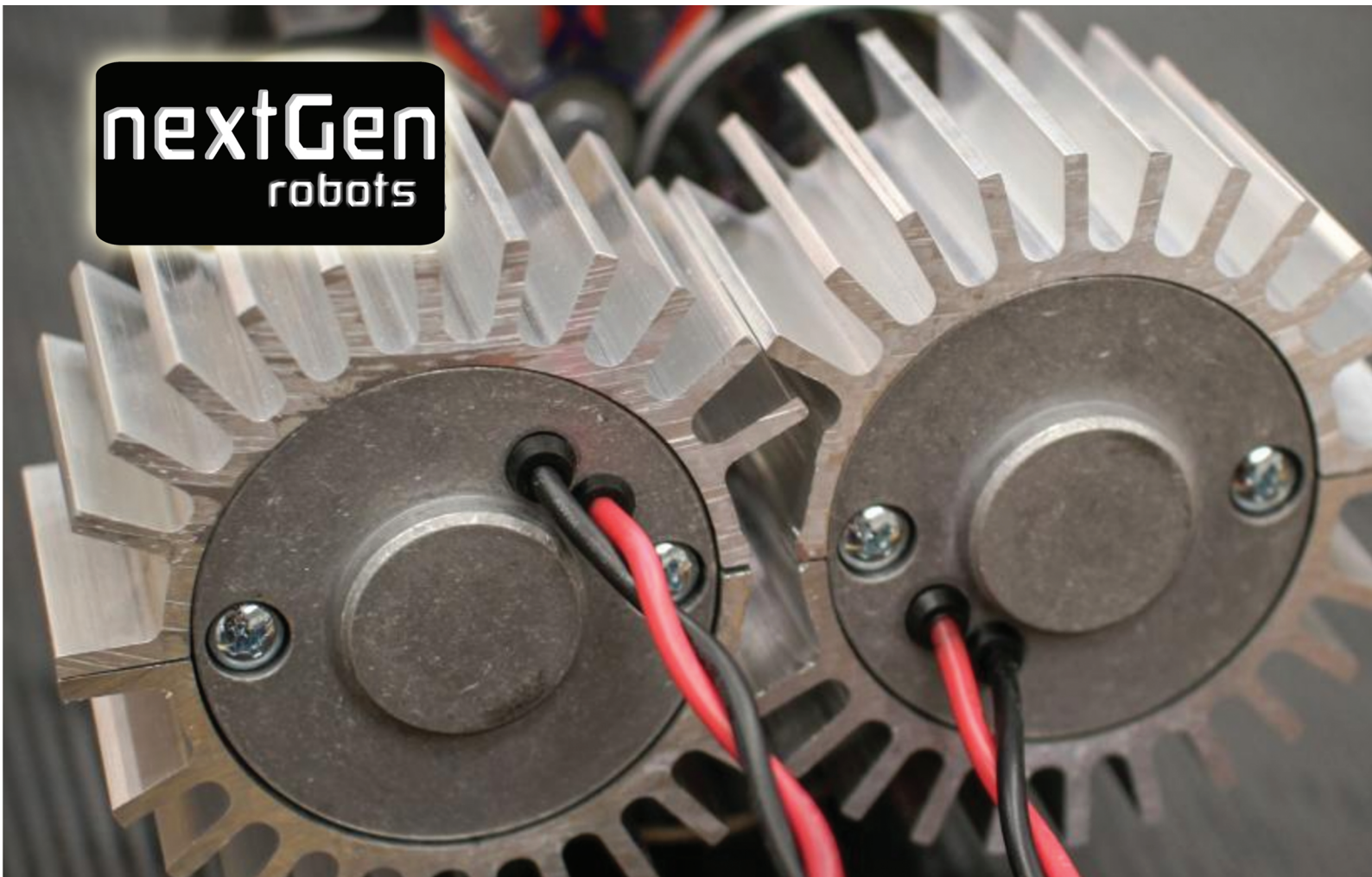



**Organization Name**

**NI / Emerson**

**Voucher Value**

**NI LabVIEW Software Suite**

**Expiration Date**

**01/31/2026**

**Shipping**

**Included**

**Access Code(s)**

**Visit Team Registration Account**

*(Lead Mentor 1 or 2)*

**Website**

**<http://www.ni.com/frc>**

This license also provides access to more than a dozen LabVIEW add-ons, NI Multisim for SPICE simulations, and NI Ultiboard for PCB design.

### **1. Access Your Team's Serial Number**

Have your Lead Mentor 1 or 2 log in to your team's account at [www.firstinspires.org](http://www.firstinspires.org) to access your serial number by clicking on "Passwords/Voucher Codes."

### **2. Download Software**

Get NI LabVIEW for *FIRST*® Robotics Competition via the *FIRST* Robotics Competition Resource Hub at [www.ni.com/frc](http://www.ni.com/frc).

### **3. Learn and Earn**

Learn LabVIEW with free online training and earn skills badges at [www.ni.com/frc](http://www.ni.com/frc).

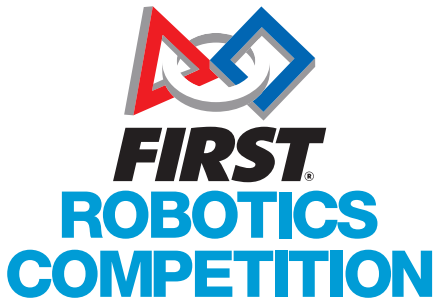



 LabVIEW™

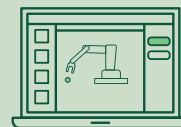

Engineer  
Ambitiously

**Accelerate your team with LabVIEW!**

Dataflow-based programming, enhanced debugging tools, and unlimited creative freedom!

[ni.com/frc](https://ni.com/frc)



**Organization Name**

**OneIPM**

**Voucher Detail**

**OneIPM Project/Task Management  
for Onshape**

**Expiration Date**

**12/31/2025**

**Shipping**

**Included**

**Access Code(s)**

**Visit Team Registration Account**  
(Lead Mentor 1 or 2)

**Website**

**[www.oneipm.com/first/](http://www.oneipm.com/first/)**

*OneIPM is pleased to provide complimentary use of our cloud-based Project/Task Management and Product Structure Explorer solution for all FIRST® teams.*

OneIPM is an Onshape add-in that provides innovative visuals of your Onshape documents and assemblies, helping teams better understand design intent, while also managing all your project related tasks with complete associativity to your CAD documents.

**To access OneIPM:**

- Create an account in Onshape at [onshape.com](http://onshape.com)
- Subscribe to the free trial of OneIPM in the Onshape app store at [appstore.onshape.com](http://appstore.onshape.com)
- Extend your free trial of OneIPM for the entire season at [oneipm.com/first/](http://oneipm.com/first/)

***For detailed information and step-by-step instruction, please visit: [oneipm.com/first/](http://oneipm.com/first/) Best wishes for a great season!***

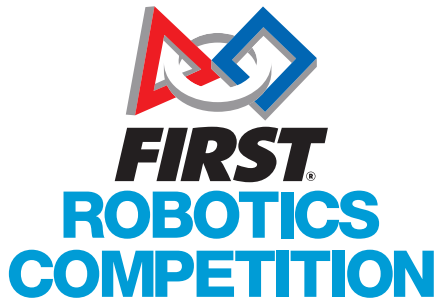



# OneIPM

Integrated Project Management

- Manage all your projects and tasks *within* Onshape
- *Link* tasks directly to documents, parts, assemblies, drawings...
- Visualize product structure with OneIPM's innovative *tree and node* views
- Gain insight into design intent using part *version history* viewer

The image displays the OneIPM software interface, which is integrated with Onshape. The top section shows a task list for a project titled "Cooling System Cost Reduction - 35%". The tasks are organized into three columns: "To Do", "In Progress", and "Done". Each task includes a description, a due date, and a status indicator. For example, in the "To Do" column, there is a task "Analyze all tolerances on final motor assembly before ordering new parts" with a due date of 2020-07-03 (4d) and a status of "Not Started". In the "In Progress" column, there is a task "Design lighter weight backing plate" with a due date of 2020-07-01 (2d) and a status of "In Progress". In the "Done" column, there is a task "Create gear drive assembly" with a due date of 2020-04-05 (1yr) and a status of "Completed".

Below the task list, there is a product structure diagram showing a hierarchical view of the product. The root node is "Fly Wheel Assy", which is connected to "Flywheel" and "CrankShaft". "Flywheel Assy" is also connected to "Drive Assy", which is connected to "Strap". "Drive Assy" is connected to "Gear Assy", which is connected to "Gear Arm", "Internal Gear", "Gear Screw", "Piston Rod End", "Crank", "Orbiting Gear", and "Piston Rod Screw".



**Organization Name**

**Plummer Industries**

**Voucher Detail**

**\$50.00**

**Expiration Date**

**09/30/2025**

**Shipping**

**Team Responsibility**

**Access Code(s)**

**Visit Team Registration Account**

*(Lead Mentor 1 or 2)*

**Website**

**<https://plummerindustries.com/robotics/shop>**

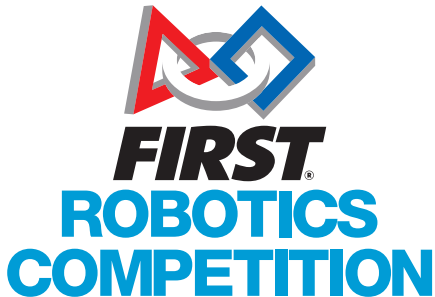

***\$50.00 for FIRST® Robotics Competition Teams to receive Plummer Industries products***

**To redeem:** *At the start of checkout teams can apply the Voucher code in the promo coupon box.*

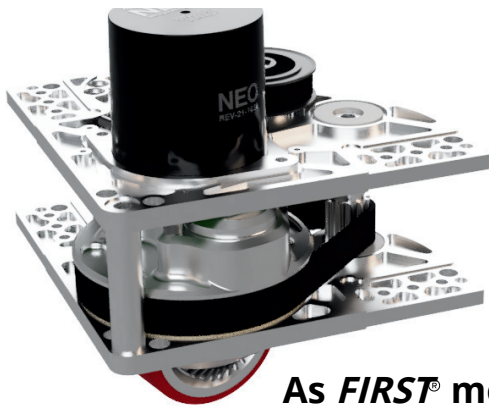

# Plummer Industries

Driving Innovation.

Drive Systems  
Bumper Mounts  
Gussets and Components

As *FIRST*® mentors and alumni we understand the need for high quality parts to meet the rigors of *FIRST*® Robotics Competition.

Use your Voucher to get parts on us!



For build assistance check out our resources page

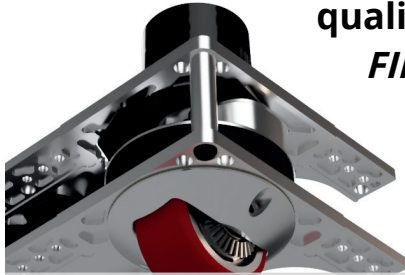

Proud Supplier



[www.plummerindustries.com/robotics](http://www.plummerindustries.com/robotics)

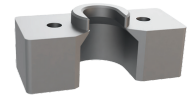

Follow us @Plummerind





**Organization Name**

**REV Robotics**

**Voucher Value**

**\$50.00**

**Offer Expires**

**05/31/2025**

**Shipping**

**Team Responsibility**

**Access code**

**Visit Team Registration Account**

*(Lead Mentor 1 or 2)*

**Website**

**[www.revrobotics.com](http://www.revrobotics.com)**

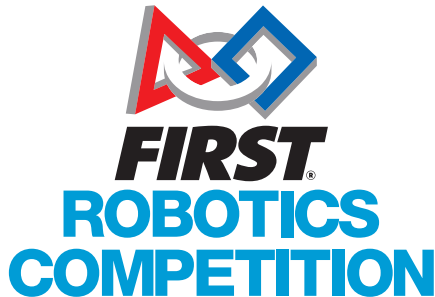

***Receive \$50 towards any products on [www.revrobotics.com](http://www.revrobotics.com).***

Enter the voucher code from your FIRSTInspires Account as “coupon code” at checkout. The voucher code is valid for one-time use only on online purchases made before May 31, 2025.

For more information, please visit: **[www.revrobotics.com/frc-voucher/](http://www.revrobotics.com/frc-voucher/)**



## Competitive Robotics Made Simple

As proud supporters of the *FIRST*® Robotics Competition, REV Robotics is committed to empowering every team to push the boundaries of innovation.



[www.revrobotics.com](http://www.revrobotics.com)

To support your journey, we're offering a \$50 voucher to each FRC team. Visit our website to learn more!

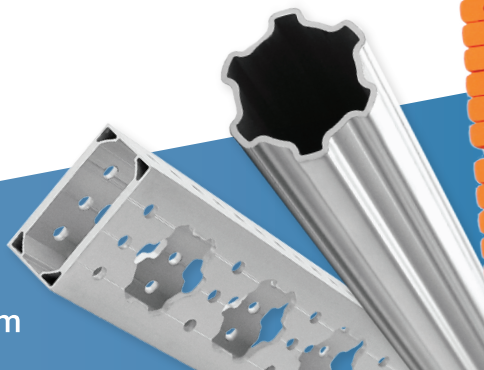

[www.revrobotics.com](http://www.revrobotics.com)



Organization Name

**RoboPromo**

Voucher Detail

**FIRST® Iron-On Bumper Logos (set of 8)**

Expiration Date

**07/01/2025**

Shipping

**Team Responsibility**

Access Code

**LOGO2025**

Website

**[www.robopromo.com](http://www.robopromo.com)**

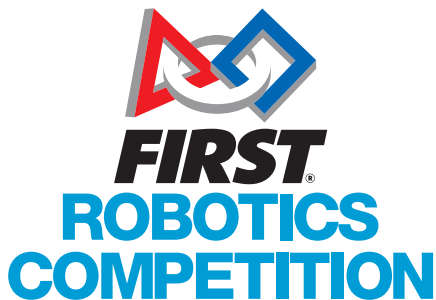
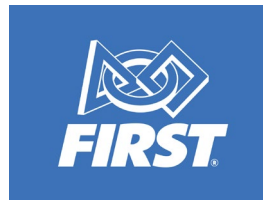

**Instructions:**

- Go to **[www.robopromo.com](http://www.robopromo.com)** and enter access code **LOGO2025** at checkout (include team number) to receive (1) pack of (8) iron-on logos: 3.75" x 5"
- *Available to FIRST® Robotics Competition Teams only.*
- *Available 01/01/2025 (one order per team)*

**ROBO**PROMO

---

PROMOTING SUCCESS

*SendCutSend*

Organization Name

**SendCutSend**

Voucher Value

**\$30.00**

Offer Expires

**12/31/2025**

Shipping

**Included**

Access code

**Complete the form at  
[sendcutsend.com/first](https://sendcutsend.com/first)**

Website

**[sendcutsend.com/first](https://sendcutsend.com/first)**

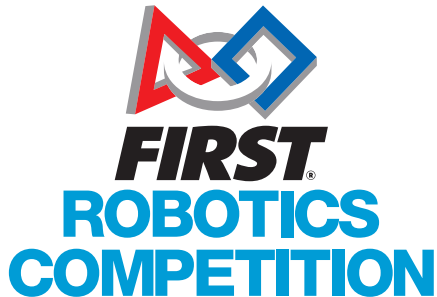

*Receive \$30 off your first order on [sendcutsend.com/first](https://sendcutsend.com/first)*

Sign up and we'll email your team a code to be used at checkout.



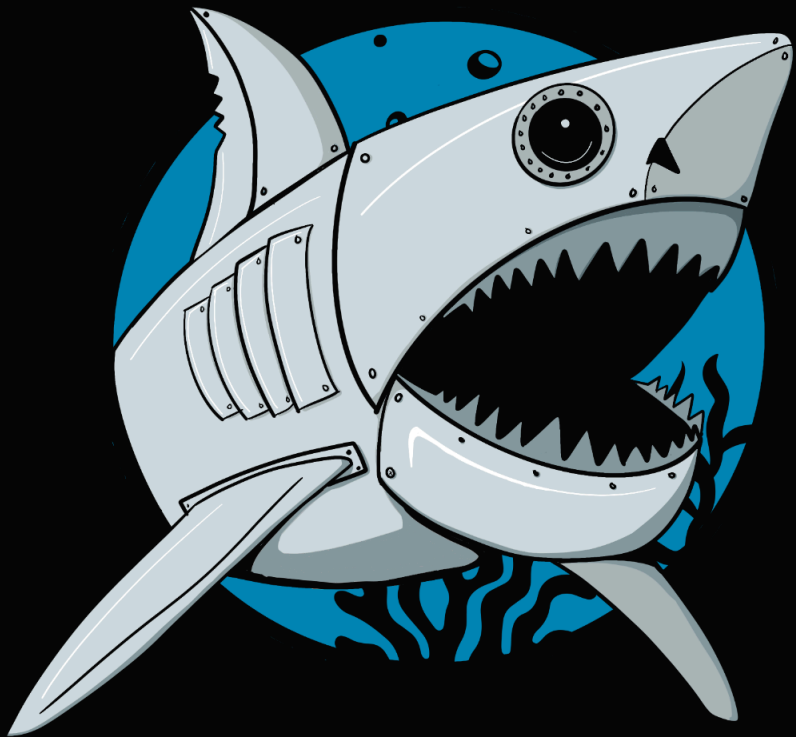

*SendCutSend*

## Easily order custom robotics parts online



No minimum quantities



Free shipping



Made in the USA



165+ materials to choose from



14 services available including cutting, bending, hole operations and finishing options



Scan to get \$30 off  
your first order!



**Organization Name**

**SmugMug**

**Voucher Detail**

**(1) year of SmugMug Pro**

**Expiration Date**

**08/31/2025**

**Shipping**

**Included**

**Access Code(s)**

**Visit Team Registration Account**

**(Lead Mentor 1 or 2)**

**Website**

[https://docs.google.com/forms/d/e/1FAIpQLSfz0eh-eLK0gLIwpiJm-BOvq9-iv796\\_b5-NV2LZ8lskxJPN\\_w/viewform](https://docs.google.com/forms/d/e/1FAIpQLSfz0eh-eLK0gLIwpiJm-BOvq9-iv796_b5-NV2LZ8lskxJPN_w/viewform)

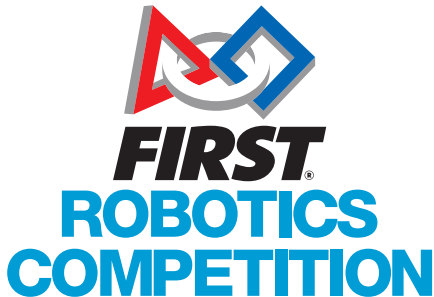

*We are excited to support the FIRST® Robotics Competition and FIRST® Tech Challenge teams for the 2024-2025 season! Please complete the form for (1) SmugMug Pro account for your team. (\$384 value).*

**To access your (1) year free membership:**

1. Complete the form on this page:

[https://docs.google.com/forms/d/e/1FAIpQLSfz0eh-eLK0gLIwpiJm-BOvq9-iv796\\_b5-NV2LZ8lskxJPN\\_w/viewform](https://docs.google.com/forms/d/e/1FAIpQLSfz0eh-eLK0gLIwpiJm-BOvq9-iv796_b5-NV2LZ8lskxJPN_w/viewform)

SmugMug 



**Organization Name**

**Dassault Systèmes**

**Voucher Detail**

**SOLIDWORKS Cloud CAD Apps**

**SOLIDWORKS Desktop**

**SOLIDWORKS Desktop + Cloud Services**

**Expiration Date**

**1 year, renewable**

**Shipping**

**Included**

**Access Code**

**Register at**

**<http://www.solidworks.com/FIRST>**

**Website**

**[WWW.SOLIDWORKS.COM/FIRST](http://WWW.SOLIDWORKS.COM/FIRST)**

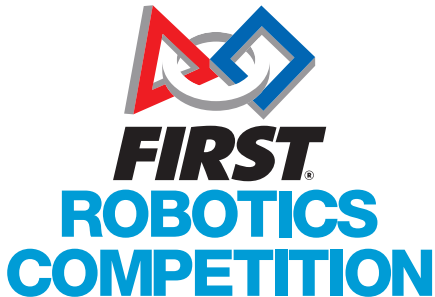

*Dassault Systèmes wants to help you develop the engineers and innovators of tomorrow. That is why we are pleased to sponsor your FIRST® team.*

Student teams needing design tools can use SOLIDWORKS Desktop, which offers solutions from design to simulation and manufacturing. SOLIDWORKS Cloud CAD Apps also provide browser-based design, cloud storage, and collaboration, enabling access to your data from anywhere. We recommend the DESKTOP + SW CLOUD Services offer for *FIRST* Teams to benefit from the robust features of SOLIDWORKS Desktop and the seamless collaboration of data and review anytime, anywhere.

**DS** SOLIDWORKS





**Organization Name**

**Voucher Value**

**Offer Expires**

**Shipping**

**Access code**

**Website**

**Swerve Drive Specialties**

**\$25.00**

**06/30/2025**

**Team Responsibility**

**Visit Team Registration Account**

*(Lead Mentor 1 or 2)*

**[www.swervedrivespecialties.com/first](http://www.swervedrivespecialties.com/first)**

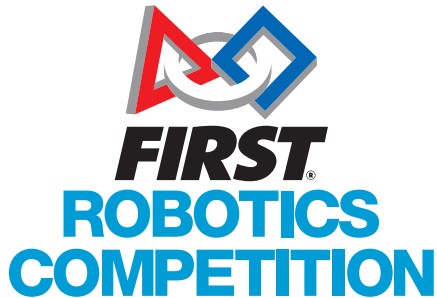

*Receive \$25 toward products available to purchase at  
[www.swervedrivespecialties.com/first](http://www.swervedrivespecialties.com/first).*

To redeem your voucher, apply the voucher code at checkout on our website. Please visit the following for additional details: **[www.swervedrivespecialties.com/first](http://www.swervedrivespecialties.com/first)**

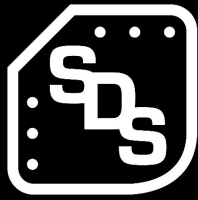

# SWERVE DRIVE SPECIALTIES



OUR COMPETITION-PROVEN SWERVE MODULES ARE THE MOST WIDELY USED IN FRC

Significant part commonality between all swerve modules, and replacement parts are available separately

4" diameter by 1.5" wide wheel for higher-speed obstacle traversal and reduced tread wear

Compatible with all major drivetrain-class brushless motors and steering encoders

Durable aerospace-grade 7075-T6 aluminum plate construction (except MK4)

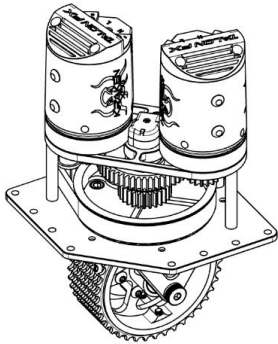

## MK4

Compact footprint  
Low cost

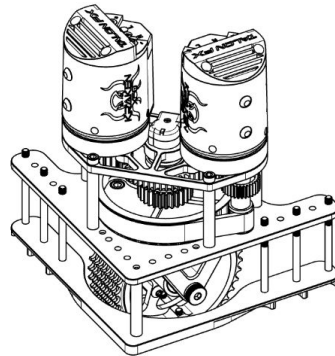

## MK4c

Compact footprint  
Large wheelbase

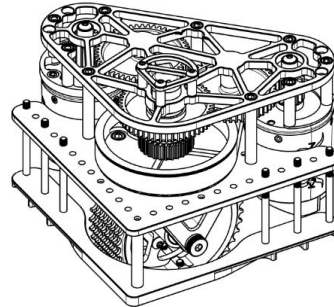

## MK4i

Low profile, triangular  
Large wheelbase

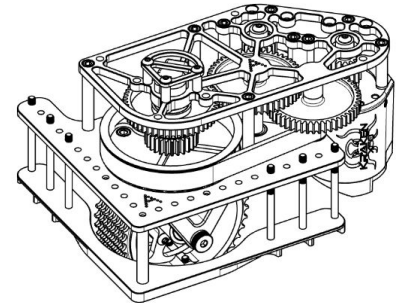

## MK4n

Low profile, narrow  
Large wheelbase

# SWYFT

**Organization Name**

**Voucher Value**

**Offer Expires**

**Shipping**

**Access code**

**Website**

**Swyft Robotics**

**Complete AprilTag Pack For 2025 Game**

**05/31/2025**

**Team Responsibility**

**Visit Team Registration Account**

*(Lead Mentor 1 or 2)*

**[swyftrobotics.com/voucher](https://swyftrobotics.com/voucher)**

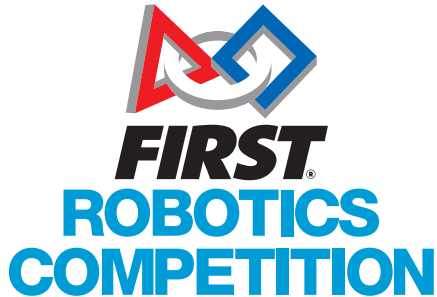

To redeem your voucher, visit [swyftrobotics.com/voucher](https://swyftrobotics.com/voucher), add the product to your cart, and then enter the code you received from *FIRST*<sup>®</sup> in the “Discount code” field during checkout.



# SWYFT

**Complete AprilTag**

**Pack For 2025**

**FREE**

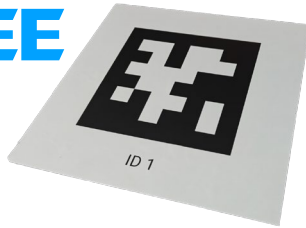

**CO2 Laser Cutter**



**DM10 CNC Machine**



**Made-To-Order BUMPERS**



**Distance Sensor**

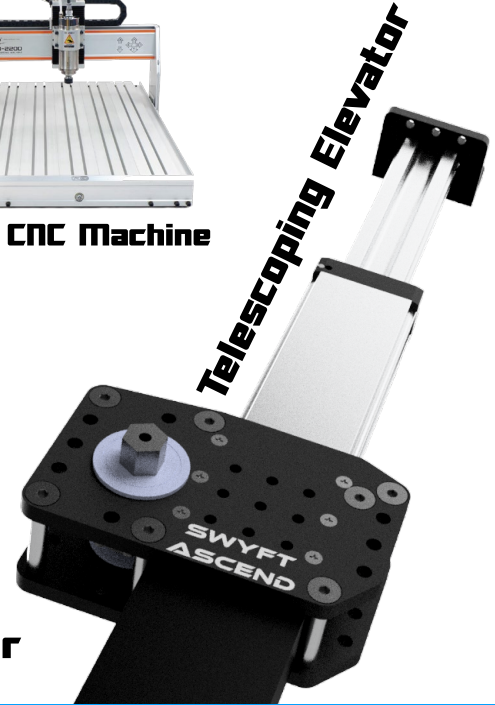

**Telescoping Elevator**

**SWYFTROBOTICS.COM**



**Organization Name**

**Tableau**

**Voucher Detail**

**One copy of Tableau Desktop**

**Expiration Date**

**09/30/25**

**Shipping**

**Included**

**Access Code(s)**

**Visit Team Registration Account**

**(Lead Mentor 1 or 2)**

**Website**

**[www.tableau.com/first-robotics](http://www.tableau.com/first-robotics)**

***(One free copy of Tableau Desktop) Complimentary access to the full professional version of Tableau Desktop for data analysis and visualization, and Tableau Prep for data preparation.***

*Get ahead with Tableau. Visualize your data. Quickly answer questions. Play better defense, pick alliance partners, analyze robot performance, target your fundraising, and reduce inventory waste.*

- Use the product code found in your Lead Mentors' 1 and 2 *FIRST*<sup>®</sup> registration accounts for five activations per team.
- Make the most of it with Tableau's free online resources (<https://www.tableau.com/first-robotics>) created specifically for *FIRST*<sup>®</sup> Robotics Competition students.

*These access codes are for educational use only. Please do not share your key with anyone outside your team.*

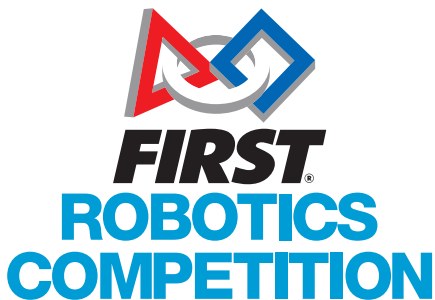



# Place **first** with Tableau

Get ahead of the competition with free access to Tableau Desktop



Discover more exclusive resources at [www.tableau.com/first-robotics](http://www.tableau.com/first-robotics)



**Organization Name**

**TE Connectivity**

**Voucher Detail**

**\$25.00**

**Expiration Date**

**01/31/2028**

**Shipping**

**Included**

**Access Code**

**n/a**

**Website**

**[www.te.com/first](http://www.te.com/first)**

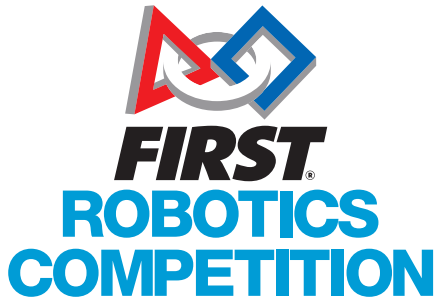

***\$25.00 for FIRST® Robotics Competition Teams to receive TE Connectivity products***

**To redeem:** All instructions are available on the on the website, where you can find the product catalog. *FIRST®* teams will use the TE Connectivity sample program to acquire parts. Explore our catalog for suggested and popular pieces!

# TOGETHER, LET'S ENGINEER THE FUTURE.

TE Connectivity has been a proud sponsor of *FIRST*® for over 20 years.

At TE, we believe that every connection has the power to engineer something bigger, and technology brings humanity together.

Learn how TE is engineering a safer, sustainable, productive, and more connected future.

[TE.com/ecc](https://www.te.com/ecc)





**Organization Name**

**Vulcan Spring & Manufacturing Co.**

**Voucher Value**

**Six Free Springs**

**Expiration Date**

**12/31/2025**

**Shipping**

**Included (U.S. and Canada)**

**Access Code(s)**

**Visit Team Registration Account**

*(Lead Mentor 1 or 2)*

**Website**

**<https://www.vulcancares.com>**

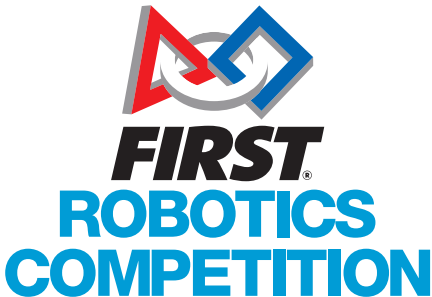

We are offering six constant force springs to each team participating in the competition. Mix and Match any springs from our constant force stock offering. The offer also includes free shipping within the USA and Canada! Orders are limited to 1 per team per year.



Sharing Spring Solutions with  
*FIRST*® Robotics Competition  
Since 2007

Beyond the Spring™ >>>





# FIRST® DIVE<sup>SM</sup>

PRESENTED BY **Qualcomm**



**FIRST®**  
**ROBOTICS**  
**COMPETITION**

200 Bedford Street  
Manchester, NH 03101 USA  
(800) 871-8326  
[firstinspires.org](http://firstinspires.org)

FIRST®, the FIRST® logo, FIRST® Robotics Competition, FIRST® Tech Challenge, REEFSCAPE<sup>SM</sup>, and FIRST® DIVE<sup>SM</sup> are trademarks of For Inspiration and Recognition of Science and Technology (FIRST). LEGO® is a registered trademark of the LEGO Group. FIRST® LEGO® League is a jointly held trademark of FIRST and the LEGO Group. All other trademarks are the property of their respective owners. ©2025 FIRST. All rights reserved. FR036